

# ALCATEL

home & business phones

## Alcatel Conference 1500



## USER'S GUIDE

# TABLE OF CONTENTS

<b>1. IMPORTANT SAFETY INSTRUCTIONS .....</b>	<b>1</b>
1.1. Package Contents	2
1.2. Location	3
<b>2. SET UP YOUR PHONE .....</b>	<b>4</b>
2.1. Connect the Base Unit	4
2.2. Activate the battery of the Wireless Microphone Unit	5
2.3. Insert the battery to the Wireless Microphone Unit	5
<b>3. GETTING TO KNOW YOUR PHONE .....</b>	<b>7</b>
3.1. Base Unit Overview	7
3.2. Wireless Microphone Unit Overview	9
<b>4. USING YOUR PHONE .....</b>	<b>10</b>
4.1. Set Date and Time	10
4.2. Change LCD language	10
4.3. Make a Call	10
4.4. Answer a Call	10
4.5. End a Call	10
4.6. Redial	11
4.7. Adjust Speaker Volume	11
4.8. Mute a Call	12
4.9. Page All Microphones	12
4.10. Temporary Ringer Silence	12
4.11. Set Up a Conference Call	12
<b>5. PHONEBOOK .....</b>	<b>13</b>
5.1. Add a New Phonebook Entry	13
5.2. Search a Phonebook Entry	13
5.3. Dial a Phonebook Entry	14
5.4. Edit a Phonebook Entry	14
5.5. Delete a Phonebook Entry	14
5.6. Delete all Phonebook Entries	14
5.7. Capacity of Phonebook	14
5.8. Speed Dial	15

<b>6. CALLER DISPLAY (Network dependent)</b> .....	<b>16</b>
6.1. View the Call List	16
6.2. Call an Entry in the Call List	16
6.3. Store a Call List Number into the Phonebook	17
6.4. Delete an Entry in the Call List	17
6.5. Delete the Entire Call List	17
<b>7. PHONE SETTINGS</b> .....	<b>18</b>
7.1. Set Ringer Volume	18
7.2. Set Ringer Melody	18
7.3. Set the Time Format	18
7.4. Set the Date Format	18
7.5. Set Key Tone	19
7.6. Change the Flash Time	19
7.7. Rename the Base Unit	19
7.8. Change Dial Mode	19
7.9. Reset Your Phone	20
7.10. Set PABX Mode	20
7.11. Set a Prefix Code	20
<b>8. TROUBLESHOOTING</b> .....	<b>21</b>
<b>9. TECHNICAL SPECIFICATIONS</b> .....	<b>22</b>
<b>10. SAFETY</b> .....	<b>23</b>
<b>11. ENVIRONMENT</b> .....	<b>24</b>

# 1. IMPORTANT SAFETY INSTRUCTIONS

When using your conference phone, basic safety precautions should always be followed to reduce the risk of fire, electric shock and injury, including the following:

1. Read and understand all instructions.
2. Follow all warnings and instructions marked on the product.
3. Unplug this product from the wall outlet before cleaning. Do not use liquid or aerosol cleaners. Use a damp cloth for cleaning.
4. Do not use this product near water such as near a bath tub, wash bowl, kitchen sink, laundry tub or swimming pool, or in a wet basement or shower.
5. Do not place this product on an unstable table, shelf, stand or other unstable surfaces.
6. Slots and openings in the back or bottom of the base unit and wireless microphone unit are provided for ventilation. To protect them from overheating, these openings must not be blocked by placing the product on a soft surface such as a bed, sofa or rug. This product should never be placed near or over a radiator or heat register. This product should not be placed in any area where proper ventilation is not provided.
7. This product should be operated only from the type of power source indicated on the marking label. If you are not sure of the type of power supply in your office, consult your dealer or local power company.
8. Do not allow anything to rest on the power cord. Do not install this product where the cord may be walked on.
9. Never push objects of any kind into this product through the slots in the base unit or wireless microphone unit because they may touch dangerous voltage points or create a short circuit. Never spill liquid of any kind on the product.
10. To reduce the risk of electric shock, do not disassemble this product, but take it to an authorized service facility. Opening or removing parts of the base unit or wireless microphone unit other than specified access doors may expose you to dangerous voltages or other risks. Incorrect reassembling can cause electric shock when the product is subsequently used.
11. Do not overload wall outlets and extension cords.
12. Unplug this product from the wall outlet and refer servicing to an authorized service facility under the following conditions:
  - When the power supply cord or plug is damaged or frayed.
  - If liquid has been spilled onto the product.
  - If the product has been exposed to rain or water.
  - If the product does not operate normally by following the operating instructions. Adjust only those controls that are covered by the operation instructions. Improper adjustment of other controls may result in damage and often requires extensive work by an authorized technician to restore the product to normal operation.
  - If the product has been dropped and the base unit and/or wireless microphone unit has been damaged.
  - If the product exhibits a distinct change in performance.
13. Avoid using the conference phone during an electrical storm. There is a remote risk of electric shock from lightning.
14. Do not use the conference phone to report a gas leak in the vicinity of the leak. Under certain circumstances, a spark may be created when the adapter is plugged into the power outlet, or when the remote microphone unit is replaced in its cradle. This is a common event associated with the closing of any electrical circuit. The user should not plug the phone into a power outlet, and should not put a charged wireless microphone unit into the cradle, if the phone is located in an environment containing concentrations of flammable or flame-supporting gases, unless there is adequate ventilation. A spark in such an environment could create a fire or explosion. Such environments might include: medical use of oxygen without adequate ventilation; industrial gases (cleaning solvents; gasoline vapors; etc.); a leak of natural gas; etc.
15. Only put the wireless microphone unit next to your ear when it is in normal talk mode.
16. The power cables are intended to be correctly oriented in a vertical or floor mount position. The prongs are not designed to hold the plug in place if it is plugged into a ceiling, under-the-table or cabinet outlet.

## 1.1. Package Contents

The package contains the following items.

- 1 Alcatel Conference 1500 base unit
- 2 Wireless microphone units
- 1 AC power cord
- 1 Interface module (AC power / To Phone & From Wall)
- 1 Telephone line cord
- 2 3.7V 240mAh Li-Polymer rechargeable batteries
- 1 6-metre connector cable
- User's guides

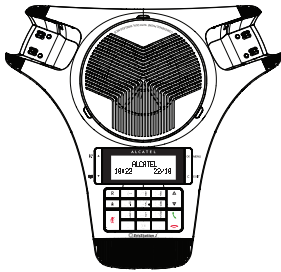

Alcatel Conference 1500  
base unit x 1



Wireless microphone  
unit x 2



3.7V 240mAh Li-Polymer  
rechargeable battery x 2

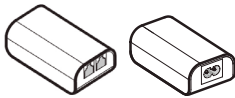

Interface module x 1



Telephone line cord x 1



6-metre connector  
cable x 1



AC power cord x 1

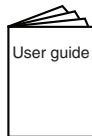

User guides

**Important:** Only use the mains power adaptor, cables, and rechargeable batteries supplied in the package. Otherwise, this product might not work. Any replacement rechargeable batteries must be of the same type.

## **1.2. Location**

For maximum coverage and reduce the interference, here are some guidelines you should consider when you place the base unit:

- place it away from electronic appliances such as televisions, microwave ovens, radios, personal computers, wireless devices, or other cordless phones.
- avoid facing radio frequency transmitters, such as external antennas of mobile phone cell stations.
- avoid plugging it into the same circuit as other major household electrical appliances because of the potential for interference. Try moving the appliance or the base unit to another power outlet.
- If the reception between a wireless microphone unit and the base unit is not satisfactory, move the units to another location for better reception.

## 2. SET UP YOUR PHONE

### 2.1. Connect the Base Unit

1. Plug one end of the 6-metre connector cable into the base unit, and then plug the other end into the interface module. Route the cord through the slots.
2. Plug one end of the telephone line cord into the interface module, and then plug the other end into the wall jack or micro-filter.
3. Plug the small end of the AC power cord into the interface module, and plug the large end into the wall power outlet.

#### **NOTE**

Always use the cables provided in the box.

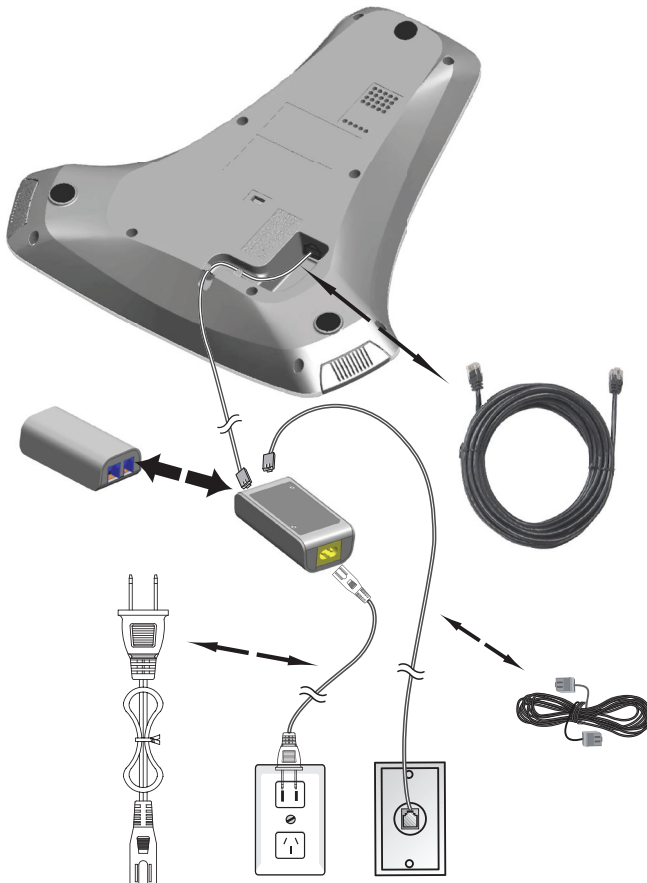

## 2.2. Activate the battery of the Wireless Microphone Unit

1. Activate the battery of each wireless microphone unit by pulling the plastic tag away from the back of the unit.

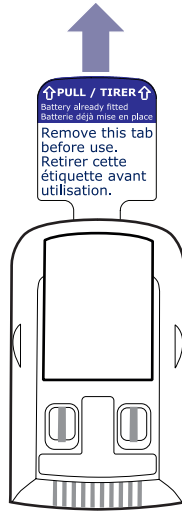

### NOTE:

- If the microphone unit still does not turn on after the pull tag is removed and charged over 8 hours, take the battery out and re-insert it by following the steps in the section 2.3.

## 2.3. Insert the battery to the Wireless Microphone Unit

1. Place the supplied rechargeable battery carefully as indicated. Pay extra attention to the direction of battery.

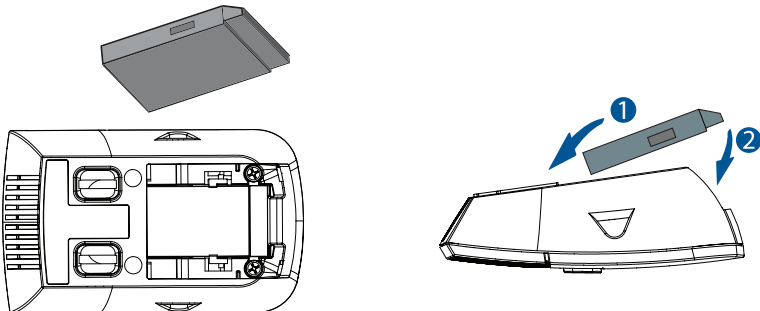



2. Slide the battery compartment cover back.

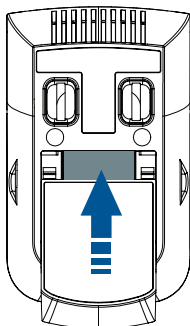

3. Put the microphone unit on the base unit and charge for 8 hours before first use. The unit will emit red light when it is properly placed on the base.

**NOTES:**

- Use only the supplied Li-ion Polymer rechargeable battery.
- If the wireless microphone units will not be used for a long time, disconnect and remove the battery to prevent possible leakage - Slide open the cover, and then press the 2 ribs outwards. After that, use finger to lift the battery from the end side, and then slowly take out the battery.

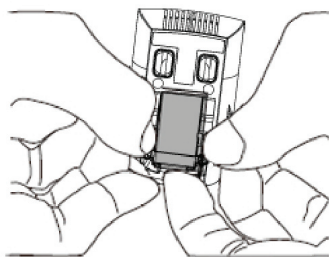

**If you have a Broadband Line**

If you connect your telephone to a line with a broadband connection, you will need to insert a micro-filter between the telephone and the telephone line. Otherwise, there may be interference between the telephone and the broadband, which could cause problems.

In a fixed line with broadband, every telephone must have a micro-filter connected, not just the one at the telephone point that your modem is connected to. If you need more broadband micro-filters, contact your broadband supplier.

## 3. GETTING TO KNOW YOUR PHONE

### 3.1. Base Unit Overview

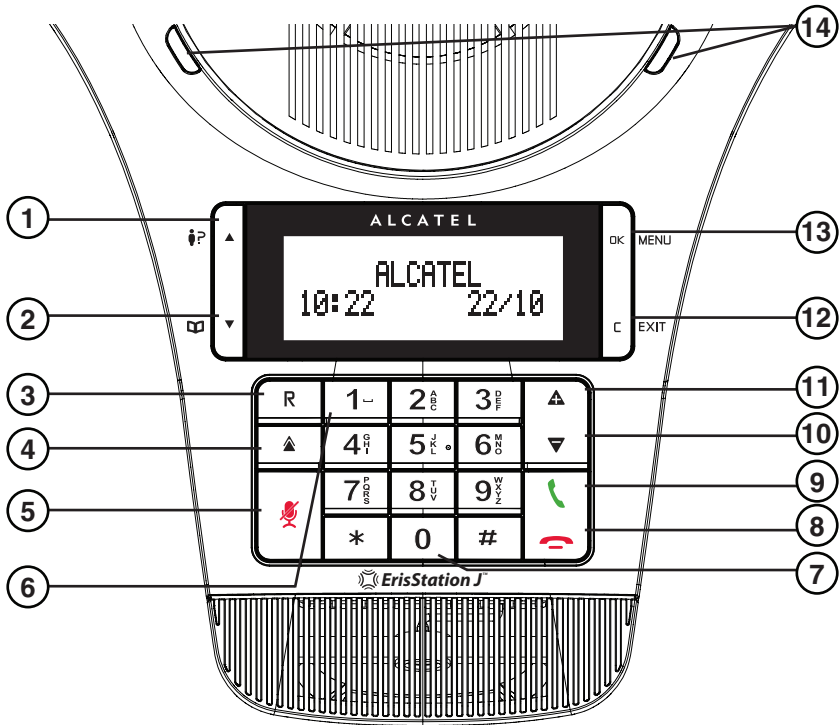

#### 1. ▲ (↑)







- In menu mode: Press to scroll up the menu items.
- In idle mode: Press to access the call list.
- While entering names or numbers in the phonebook: Press to move the cursor to the right.

#### 2. ▼ (↓)

- In menu mode: Press to scroll down the menu items.
- In idle mode: Press to access the phonebook.
- While entering names or numbers in the phonebook: Press to move the cursor to the left.

#### 3. R

- In idle / predialing mode: Press to insert a flash.
- During a call: Press to dial a flash.
- Set up conference call (see section 4.11).

4. 
  - In Idle mode: Press to access the redial list.
5. 
  - During a call: Press to mute/unmute all microphones in the system.
6. **1** 
  - Press to insert a space when entering names.
7. **0**
  - Press and hold to insert a dialing pause when entering numbers.
8. 
  - Press to end a call.
9. 
  - Press to make or answer a call.
10. 
  - Press to decrease ringer or speaker volume.
11. 
  - Press to increase ringer or speaker volume.
12. **C (EXIT)**
  - Press to go back or delete a character.
  - Press and hold to delete all characters.
13. **OK (MENU)**
  - Press to select a menu item displayed next to the key.
  - While in a menu: Press to select an item or save an entry or setting.
14. **LED Lights**
  - **Green** during a call.
  - **Red** when mute is on.
  - Flashing **Green** when there is an incoming call.

## 3.2. Wireless Microphone Unit Overview

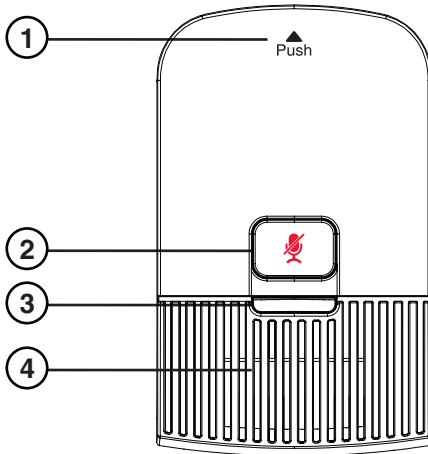

### 1. PUSH

- Press the  position, and then lift the wireless microphone unit from the base during a call.

### 2.

- During a call: Press to mute/unmute all microphones in the system.
- Muted when the wireless microphone units are on the base unit charging cradles.

### 3. LED Light

- **Green** when the wireless microphone units are lifted from the base unit charging cradles during a call.
- Flashing **Green** when there is an incoming call.
- **Red** when charging, or when all microphones are muted.
- Flashing **Red** quickly when there is low battery.
- Flashing **Red** slowly when the wireless microphone units are out of range of the base unit.
- **Orange** when fully charged.

### 4. Microphone

## 4. USING YOUR PHONE

### 4.1. Set Date and Time

You should set the correct time and date before use.

1. Press **OK** on the base unit in idle mode to enter the main menu.
2. Press **▼** or **▲** to select **SET DATE/TIME**, and then press **OK**.
3. Press **▼** or **▲** to select the day, and then press **OK**.
4. Press **▼** or **▲** to select the month, and then press **OK**.
5. Press **▼** or **▲** to select the year, and then press **OK**.
6. Press **▼** or **▲** to select the hour, and then press **OK**.
7. Press **▼** or **▲** to select the minutes, and then press **OK**. You hear a confirmation tone.

### 4.2. Change LCD language

1. Press **OK** on the base unit in idle mode to enter the main menu.
2. Press **▼** or **▲** to select **SETTINGS**, and then press **OK**.
3. Press **▼** or **▲** to select **LCD LANGAUGE**, and then press **OK**.
4. Press **▼** or **▲** to select desired language, and then press **OK**. You hear a confirmation tone.

### 4.3. Make a Call

#### 4.3.1 Preparatory Dialing

Enter the phone number, and then press  to dial the number. To clear the entry, press **C**.

#### 4.3.2. Direct Dialing

Press  to take the line, and then enter the phone number to dial.

### 4.4. Answer a Call

Press .





### 4.5. End a Call

During a call, press . After the call ends, put all wireless microphone units back to the base unit charging cradles.

## 4.6. Redial

The base unit stores the last 10 dialed numbers (up to 30 digits each) in the redial list.

### 4.6.1. Review the Redial List

1. Press  in idle mode.
2. Press ,  or  repeatedly to browse the list. The base unit beeps twice at the end of the list.
3. Press **C** to exit.

### 4.6.2. Dial a Redial Entry

1. Repeat steps 1 and 2 in section 4.6.1.
2. Press .

### 4.6.3. Save a Redial Entry to the Phonebook

1. Repeat steps 1 and 2 in section 4.6.1.
2. Press **OK** twice.
3. The base unit displays **EDIT NUMBER**. Use the dialing keys to edit the number.
4. Press **OK**, the base unit displays **ENTER NAME**. Use the dialing keys to input name.
5. Press **OK**, and then **SAVED** displays. You hear a confirmation tone.



### 4.6.4. Delete a Redial Entry

1. Repeat steps 1 and 2 in section 4.6.1.
2. Press **OK**, and then  to select **DELETE**.
3. Press **OK** to delete the displayed number. You hear a confirmation tone.

### 4.6.5. Delete the Entire Redial List

1. Repeat steps 1 and 2 in section 4.6.1.
2. Press **OK**, and then  to select **DELETE ALL**.
3. Press **OK**, the screen displays **DELETE ALL ENTRIES?** Press **OK** to delete all redial numbers. You hear a confirmation tone. The screen displays **DELETED**.



## 4.7. Adjust Speaker Volume

During a call, press  or  to increase or decrease the speaker volume.

## 4.8. Mute a Call

You can talk to someone nearby without letting the caller hear you during a call.

### During a call:

Press  to mute all microphones in the system and **MUTED** will display on the screen. Your caller cannot hear you. Press  again to unmute all microphones in the system.

## 4.9. Page All Microphones

You can page the wireless microphone units to help you relocate them.

1. Press **OK** in idle mode.
2. Press **▼** or **▲** to select **FIND ALL MICS**, and then press **OK**.
3. All registered wireless microphone units that are outside charging cradles and within range will beep for 60 seconds.
4. To stop the paging beep, press  on the wireless microphone unit or place it back to the base unit charging cradles.

## 4.10. Temporary Ringer Silence

When the telephone is ringing, you can temporarily silence the ringer of the base unit without disconnecting the call. The next call rings normally at the preset volume.

### To silence the ringer:

1. Press  on the base unit and **RINGER MUTED** displays.

## 4.11. Set Up a Conference Call

If your telephone system supports 3-party call conferencing, you can set up a conference call.

1. Press .
2. When you hear a dial tone, dial the first phone number.
3. When the first call is answered, press **R** to put the first call on hold.
4. When you hear a dial tone, dial the second phone number.
5. When the second call is answered, press **R**. Your conference call starts.

This conference call descriptions may vary depending on your local public network or your private telephone system. Please contact your local operator or phone installer.

## 5. PHONEBOOK

The phonebook stores up to 50 entries, with up to 30 digits for each phone number and 15 characters for each name.

- When there are no records in the phonebook, the screen displays **PHONE EMPTY**, and then **ADD CONTACT?**.
- When the phonebook is full and you try to save an entry, the screen displays **PHONEBOOK FULL**.
- When you try to add an entry already stored in the phonebook, the base unit displays **NUMBER ALREADY SAVED**.

### 5.1. Add a New Phonebook Entry

1. Press **OK** in idle mode to select **PHONEBOOK**, and then press **OK**.

1.1. If phonebook is empty, the screen displays **ADD CONTACT?**

Press **OK**. The screen displays **ENTER NUMBER**.

1.2. If phonebook record is available, press **OK**, and then **▼** to select **ADD CONTACT**. The screen displays **ENTER NUMBER**.

2. Enter a telephone number.

**OR**

Copy a number from the redial list.

- Press **▲**, and then **▼**, **▲**, or **▲** repeatedly to browse for a number.

Press **OK** to copy the displayed number.

3. Press **OK**. The screen displays **ENTER NAME**.

4. Enter the name:

- Press **▼** or **▲** to move the cursor to the left or right respectively.
- Press **1**– to add a space.
- Press **C** to delete a character.
- Press and hold C to delete all characters.
- Press **OK** to confirm and the screen displays **SAVED**. You hear a confirmation tone.

### 5.2. Search a Phonebook Entry

1. Press **▼** (**🔍**) in idle mode.

2. Press **▼** or **▲** to select a phonebook entry, or use your keypad to enter first letter of the name you are looking for.



### 5.3. Dial a Phonebook Entry

1. Search for the desired entry in the phonebook.
2. Press .

### 5.4. Edit a Phonebook Entry

1. Search for the desired entry in the phonebook, and then press **OK**.
2. The screen displays **EDIT CONTACT**. Press **OK**.
3. The screen displays **EDIT NUMBER**. Edit the number, and then press **OK**.
4. The screen displays **EDIT NAME**. Edit a name, and then press **OK**.
5. The screen displays **SAVED**. You hear a confirmation tone.

### 5.5. Delete a Phonebook Entry

1. Search for the desired entry in the phonebook.
2. Press **OK**, and then ▼ to select **DELETE**. Press **OK**. The screen displays **DELETE CONTACT?** and the name of the entry. Press **OK** to confirm.
3. The screen displays **CONTACT DELETED**. You hear a confirmation tone, and then the next alphabetical entry in the phonebook.

### 5.6. Delete all Phonebook Entries

1. Press **OK** in idle mode to select Phonebook, and then press **OK** twice.
2. Press ▼ to select **DELETE ALL**. Press . The screen displays **DELETE ALL CONTACTS?** Press **OK** to confirm. The screen displays **ALL CONTACTS DELETED**. You hear a confirmation tone.

### 5.7. Capacity of Phonebook

1. Press **OK** in idle mode to select Phonebook, and then press **OK** twice.
2. Press ▼ to select **CAPACITY**. Press **OK** to confirm. The screen displays **CAPACITY X/50 USED**. (**X** is the number of phonebook entries stored).

## 5.8. Speed Dial

You can assign 5 of your phonebook entries to a speed dial location (1, 2, 3, 4, and 5).

### 5.8.1. Set a Speed Dial Number

1. Press **OK** in idle mode to select **PHONEBOOK**, and then press **OK** twice.
2. Press **▼** or **▲** to select **SPEED DIAL**, and then press **OK**.
3. Press **▼** or **▲** to select an empty slot (1-5), and then press **OK**.
4. The screen displays **COPY FROM PHONEBOOK**, and then press **▼** or **▲** to select your desired phonebook.
5. When the desired entry appears, and then press **OK**. You hear a confirmation tone.

### 5.8.2. Change a Speed Dial Entry

1. Press **OK** in idle mode to select **PHONEBOOK**, and then press **OK** twice.
2. Press **▼** or **▲** to select **SPEED DIAL**, and then press **OK**.
3. Press **▼** or **▲** to select an empty slot (1-5), and then press **OK**.
4. Select **EDIT**, and then press **OK**.
5. Press **▼** or **▲** to select the name you want to change.
6. Press **OK** to save the new entry. You hear a confirmation tone.

### 5.8.3. Dial a Speed Dial Entry

1. In idle mode, press and hold a desired speed dial key (1, 2, 3, 4, and 5).

### 5.8.4. Delete a Speed Dial Entry

1. Press **OK** in idle mode to select **PHONEBOOK**, and then press **OK** twice.
2. Press **▼** or **▲** to select **SPEED DIAL**, and then press **OK**.
3. Press **▼** or **▲** to select an empty slot (1-5), and then press **OK**.
4. Press **▼** to select **DELETE**, and then press **OK**. The screen displays **SPEED DIAL EMPTY**. You hear a confirmation tone.

## 6. CALLER DISPLAY (Network dependent)

This feature is available if you have subscribed the Caller ID service with your telephone service provider.

### **NOTE:**

**Alcatel Conference 1500** does not display caller number during call waiting.

Your phone can store up to 50 received calls with date/time information in the call list. The number will be shown on the screen when the phone is ringing. If the number matches with one of the entries in your private phonebook, the caller's name stored in the private phonebook will be displayed with the number.

If the caller number is disabled to send caller information, **WITHHELD** will be displayed.

If the caller number is not provided by the network, **UNAVAILABLE** will be displayed.

In idle mode, if three unanswered calls are received, "**3 MISSED CALLS**" will be displayed. Whenever you enter the call list, or the base unit resumes power after power outage, the missed call indicator goes away.

If the incoming telephone number matches the last 7 digits of a telephone number in your phonebook, the name that appears on the screen matches the corresponding name in your phonebook.

### 6.1. View the Call List

All received calls are saved in call list with the latest call placed at the top of the list. When the call list is full, the oldest call will be replaced by a new call.

1. In idle mode, press ▲ (i?) to review the calling number display history.

#### **OR**

You can also review the calling number display history by pressing **OK**, and then ▼ or ▲ to select to **CALL LIST**, and then press **OK**.

2. Press ▼ or ▲ to browse.

### 6.2. Call an Entry in the Call List

1. Refer to **View the Call List**.

2. Press .

### 6.3. Store a Call List Number into the Phonebook

1. Select a desired entry in the call list, and then press **OK**. The screen displays **STORE TO PB**.
2. Press **OK**. The screen displays **EDIT NUMBER**.
3. Edit the number, and then press **OK**. The screen displays **EDIT NAME**
4. Edit the name, and then press **OK** to confirm. The screen displays **SAVED**. You hear a confirmation tone.

### 6.4. Delete an Entry in the Call List

1. Select a desired entry in the call list.
2. When the desired entry is displayed, press **OK**.
3. Press ▼ to select **DELETE**, and press **OK**. The screen displays the next call list entry. You hear a confirmation tone.

### 6.5. Delete the Entire Call List

1. Select a desired entry in the call list.
2. When the desired entry is displayed, press **OK**.
3. Press ▼ to select **DEL ALL CALLS**, and then press **OK** to confirm. The screen displays **DELETE ALL CALLS?**
4. Press **OK** to confirm. You hear a confirmation tone.

## 7. PHONE SETTINGS

### 7.1. Set Ringer Volume

1. In idle mode, press **OK**.
2. Press ▼ or ▲ to select **RINGERS**, and then press **OK**.
3. Press **OK** to select **RINGER VOLUME**.
4. Press ▼ or ▲ to adjust the ringer volume. You hear a sample of each volume level while adjusting.
5. Press **OK** to save. You hear a confirmation tone.

#### **OR**

Select **RINGER OFF** to turn off, and then press **OK** to save. You hear a confirmation tone.

### 7.2. Set Ringer Melody

1. In idle mode, press **OK**.
2. Press ▼ or ▲ to select **RINGERS**, and then press **OK**.
3. Press ▼ or ▲ to select **RINGER TONE**, and then press **OK**.
4. Press ▼ or ▲ to choose your desired ringer tone.
5. Press **OK** to save. You hear a confirmation tone.

### 7.3. Set the Time Format

1. In idle mode, press **OK**.
2. Press ▼ or ▲ to select **SETTINGS**, and then press **OK**.
3. Press **OK** to select **TIME FORMAT**.
4. Press ▼ or ▲ to choose your desired time format (**12-HOUR** or **24-HOUR**).
5. Press **OK** to confirm. You hear a confirmation tone.

### 7.4. Set the Date Format

1. In idle mode, press **OK**.
2. Press ▼ or ▲ to select **SETTINGS**, and then press **OK**.
3. Press ▼ or ▲ to select **DATE FORMAT**, and then press **OK**.
4. Press ▼ or ▲ to select your desired date format (**DD/MM/YY** or **MM/DD/YY**).
5. Press **OK** to confirm. You hear a confirmation tone.

## 7.5. Set Key Tone

It is set to beep with each key press if you turn on the beep tone.

1. In idle mode, press **OK**.
2. Press ▼ or ▲ to select **SETTINGS**, and then press **OK**.
3. Press ▼ or ▲ to select **KEY TONE**, and then press **OK**.
4. Press ▼ or ▲ to adjust the key tone volume. You hear a sample of each key tone volume while adjusting. Press **OK** to save your preference.

**OR**

Select **OFF** to turn off, and then press **OK** to save. You hear a confirmation tone.

## 7.6. Change the Flash Time

1. In idle mode, press **OK**.
2. Press ▼ or ▲ to select **SETTINGS**, and then press **OK**.
3. Press ▼ or ▲ to select **FLASH TIME**, and then press **OK**.
4. Press ▼ or ▲ to select your desired flash time (80ms, 100ms, 120ms, 180ms, 200ms, 250ms, 300ms, or 600ms), and then press **OK**. You hear a confirmation tone.

## 7.7. Rename the Base Unit

1. In idle mode, press **OK**.
2. Press ▼ or ▲ to select **SETTINGS**, and then press **OK**.
3. Press ▼ or ▲ to select **RENAME BASE**, and then press **OK**.
4. Edit the name, and then press **OK**. You hear a confirmation tone.

## 7.8. Change Dial Mode

1. In idle mode, press **OK**.
2. Press ▼ or ▲ to select **SETTINGS**, and then press **OK**.
3. Press ▼ or ▲ to select **DIAL MODE**, and then press **OK**.
4. Press ▼ or ▲ to select to select **TONE** or **PULSE**, and then press **OK**. You hear a confirmation tone.

## 7.9. Reset Your Phone

You can reset your phone to the default settings. After reset, all your customized settings will be deleted, but your phonebook and speed dial entries will remain unchanged.

1. In idle mode, press **OK**.
2. Press ▼ or ▲ to select **SETTINGS**, and then press **OK**.
3. Press ▼ or ▲ to select **RESET**, and then press **OK**. The screen displays **RESET TO DEFAULT?**.
4. Press **OK** to confirm. You hear a confirmation tone.

## 7.10. Set PABX Mode

If the **Alcatel Conference 1500** unit is connected to a PABX system, you should set the **Behind PABX** mode on.

1. In idle mode, press **OK**.
2. Press ▼ or ▲ to select **SETTINGS**, and then press **OK**.
3. Press ▼ or ▲ to select **BEHIND PABX**, and then press **OK**.
4. Press or ▼ or ▲ to select **YES** or **NO**, and then press **OK** to confirm. You hear a confirmation tone.

### Remarks:

- When you connect it behind PABX system, you should need to turn **BEHIND PABX** on, acoustic performance of **Alcatel Conference 1500** should be better suited behind PABX system.
- When you connect it behind public telephone network or through broadband operator, you may need to turn **BEHIND PABX** off.

## 7.11. Set a Prefix Code

Normally, when you turned **Behind PABX** on, you can set a prefix (e.g. 9) before each number is dialed externally from the call list.

1. In idle mode, press **OK**.
  2. Press ▼ or ▲ to select **SETTINGS**, and then press **OK**.
  3. Press ▼ or ▲ to select **PREFIX CODE**, and then press **OK**.
  4. Enter the number you want (maximum 1 digit), and then press **OK**.
- If the number is added already, press **C** to delete the original number. Input a new digit, and then press **OK** to confirm. You hear a confirmation tone.

## 8. TROUBLESHOOTING

If you have difficulty with your phone, please try the suggestions listed below. As a general rule, if a problem occurs, remove the batteries from all the wireless microphone units in your installation for about 1 minute, and then disconnect and reconnect the power supply to the base and reinstall the batteries carefully.

The conference phone doesn't work.	<ul style="list-style-type: none"> <li>Make sure all cables are plugged in correctly and the batteries are installed and charged. After use, remember to put your wireless microphone units back to the base unit charging cradles for charging.</li> </ul>
This display shows <b>NO LINE</b> . I cannot hear the dial tone.	<ul style="list-style-type: none"> <li>Disconnect the telephone line cord from your telephone and connect it to another telephone. If there is no dial tone on that other telephone either, then the telephone line cord may be defective. Try installing a new telephone line cord.</li> <li>If changing telephone line cord does not help, the wall jack (or the wiring to this wall jack) may be defective. Contact your telephone service provider.</li> <li>You may be using a new cable or VoIP service, the existing telephone jacks in your home may no longer work. Contact your service provider for solutions.</li> </ul>
Wireless microphone unit doesn't work	<ul style="list-style-type: none"> <li>Make sure all cables of the base unit are plugged in correctly.</li> <li>Make sure the base unit is not placed near other DECT phones or electronic devices that could cause interference.</li> <li>Make sure your wireless microphone unit is not moved out of range – try moving it closer.</li> <li>Put back your wireless microphone unit on the base unit charging cradles for 8 hours. If it still doesn't work, the battery may be flat, dead, or incorrectly inserted. Recharge or replace the battery, and then follow the procedures below to do registration again:             <ol style="list-style-type: none"> <li>When the base unit is in idle, put all wireless microphone units onto the base unit charging cradles.</li> <li>Enter the registration code <b>*331734#</b> quickly, and then press <b>OK</b> twice at base unit.</li> <li>If registration is successful, the display will show <b>"REGISTRATION DONE"</b>.</li> </ol> </li> <li>Try resetting the base unit. Unplug its power and wait for 15 seconds. Then, plug it back in, and give it a minute to reset.</li> </ul>
There's a red light flashing on my wireless microphone unit.	<ul style="list-style-type: none"> <li>Put the wireless microphone unit on the base unit so it can charge. If this doesn't work, replace the battery.</li> </ul>
The base unit doesn't ring	<ul style="list-style-type: none"> <li>The ringer volume may be switched off.</li> <li>Make sure all cables of the base unit are plugged in correctly.</li> <li>Make sure the base unit is not placed near other DECT phones or electronic devices that could cause interference.</li> <li>Try resetting the base unit. Unplug its power and wait for 15 seconds. Then, plug it back in, and give it a minute to reset.</li> </ul>



## 9. TECHNICAL SPECIFICATIONS

Indoor Range (wireless microphone unit)	Up to 30 metres*
Battery Life (wireless microphone unit) (average values)	Up to 5 hours talk time** Up to 70 hours standby**
Number of Wireless microphone units connected to the base unit	Up to 2
Electrical Connection/Base Mains Adaptor	Base main adaptor (interface module): Model No.: S018AGP0900200 Input: 100-240 V/50-60 Hz/500mA Output: 9VDC/2A Only use the adaptor supplied with telephone. Single-phase AC, excluding IT install defined by the EN60950 standard. Caution: The network voltage is classified as hazard by the criteria of this standard.
Telephone Connection	Appliance designed for connection to a TNV3 class (telecommunications network voltage) analogue telephone line as defined by the EN60950 standard.
Batteries (in each wireless microphone unit)	Battery pack – 3.7 V – 240mAh (Li-ion Polymer) Only use the batteries supplied with the telephone. Use any other type of battery presents a risk of explosion. Used batteries must be disposed of in compliance with current environmental protection regulations.
Operating Temperature	From 5°C to 40°C

\* Values may vary according to environment.

\*\* Depending on initial battery charge.

## 10. SAFETY

In the event of an electrical hazard, the mains adapter acts as 230V power isolating device. It should therefore, as a precaution, be installed close to the appliance and be easily accessible. To disconnect the device from the primary power source, the mains adapter must be removed from the 230V AC / 50 Hz socket.

If the mains adapter fails, it must be replaced by an identical model.

If not connected to the mains power or if there is a mains power failure, telephones that use cordless handsets will not work. You will then be unable to make or receive calls in the event of an emergency.

This is why we recommend that you also keep a conventional telephone – one that doesn't require a power supply – as a backup.

***! Do not use your telephone to notify a gas leak when standing in the vicinity of the leak.***

It is recommended that you avoid using this device during electrical storms.

Do not attempt to open the batteries, as they contain chemical substances. In the event of leakage, avoid contact with the skin, eyes, nose and mouth. In the event of contact, rinse the affected part for about twenty minutes with running water and seek urgent medical attention.

Clean the product with absorbent paper or a dry cloth and contact your reseller for replacement batteries.

ATLINKS hereby declares that the following models conform to the essential requirements and other applicable provisions of European directive 1999/5/EC.

### **Alcatel Conference 1500**

You can download the Declaration of Conformity from our website:

**[www.alcatel-business.com](http://www.alcatel-business.com)**



## 11. ENVIRONMENT



This symbol means that your inoperative electronic appliance must be collected separately and not mixed with the household waste. The European Union has implemented a specific collection and recycling system for which producers are responsible.

This appliance has been designed and manufactured with high quality materials and components that can be recycled and reused. Electrical and electronic appliances are liable to contain parts that are necessary in order for the system to work properly but which can become a health and environmental hazard if they are not handled or disposed of in the proper way. Consequently, please do not throw out your inoperative appliance with the household waste.

If you are the owner of the appliance, you must deposit it at the appropriate local collection point or leave it with the vendor when buying a new appliance.

- If you are a professional user, please follow your supplier's instructions.
- If the appliance is rented to you or left in your care, please contact your service provider.

Keen to preserve the environment, ATLINKS has equipped this appliance with a switching power supply, offering better energy efficiency. The advantages include not only very low electricity consumption, but also a more compact format than the conventional power supply units used by the previous range.

The used batteries from your telephone (if it has batteries) must be disposed of in compliance with current environmental protection regulations. Comply with your local regulations.

Return your batteries to your reseller or dispose of them at an approved recycling centre.

**Help us protect the environment in which we live!**

[www.alcatel-business.com](http://www.alcatel-business.com)

ATLINKS Europe  
22 quai Gallieni  
92150 Suresnes- France

© ATLINKS 2015 - Reproduction prohibited.

The Manufacturer reserves the right to modify the specifications of its products in order to make technical improvements or comply with new regulations.

ALCATEL and ATLINKS are registered trademarks.

The Alcatel logo and Alcatel name are trademarks of Alcatel-Lucent and used under licence by ATLINKS.

ErisStation J™ is the trademark of VTech Communications, Inc., registered in the United States.

Alcatel Conference 1500  
A/W No.: 10001227 Rev.0 (EN)  
Printed in PRC