



2N[®] Helios IP Uni

Door Entry IP Intercom



Installation Manual

Version: 2.7

www.2n.cz

The 2N TELEKOMUNIKACE a.s. is a Czech manufacturer and supplier of telecommunications equipment.



The product family developed by 2N TELEKOMUNIKACE a.s. includes GSM gateways, private branch exchanges (PBX), and door and lift communicators. 2N TELEKOMUNIKACE a.s. has been ranked among the Czech top companies for years and represented a symbol of stability and prosperity on the telecommunications market for almost two decades. At present, we export our products into over 120 countries worldwide and have exclusive distributors on all continents.



2N[®] is a registered trademark of 2N TELEKOMUNIKACE a.s. Any product and/or other names mentioned herein are registered trademarks and/or trademarks or brands protected by law.



2N TELEKOMUNIKACE a.s. administers the FAQ database to help you quickly find information and to answer your questions about 2N products and services. On www.faq.2n.cz you can find information regarding products adjustment and instructions for optimum use and procedures „What to do if...“.



2N TELEKOMUNIKACE a.s. hereby declares that the 2N[®] product complies with all basic requirements and other relevant provisions of the 1999/5/EC directive. For the full wording of the Declaration of Conformity see the CD-ROM (if enclosed) or our website at www.2n.cz.



This device complies with part 15 of the FCC Rules. Operation is subject to the following two conditions: (1) This device may not cause harmful interference, and (2) this device must accept any interference received, including interference that may cause undesired operation.



The 2N TELEKOMUNIKACE a.s. is the holder of the ISO 9001:2009 certificate. All development, production and distribution processes of the company are managed by this standard and guarantee a high quality, technical level and professional aspect of all our products.

Content:

- 1. Product Overview
 - 1.1 Components and Associated Products
 - 1.2 Terms and Symbols
- 2. Description and Installation
 - 2.1 Before You Start
 - 2.2 Mechanical Installation
 - 2.3 Electric Installation
 - 2.4 Button Tags
 - 2.5 Extending Module Connection
- 3. Function and Use
 - 3.1 Configuration
 - 3.2 Control
 - 3.3 Maintenance
 - 3.4 Downloads
- 4. Technical Parameters
- 5. Supplementary Information
 - 5.1 Troubleshooting
 - 5.2 Directives, Laws and Regulations
 - 5.3 General Instructions and Cautions

1. Product Overview

Here is what you can find in this section:

- 1.1 Components and Associated Products
- 1.2 Terms and Symbols

Basic Features

2N[®] Helios IP Uni is a highly resistant and reliable IP door access intercom provided with a lot of useful above-standard functions. Supporting the SIP standard and being compatible with the leading IP PBX and telephone suppliers, 2N[®] Helios IP Uni can make use of all VoIP services. 2N[®] Helios IP Uni can work as a standard or emergency door access intercom for buildings, entrances to premises or garages, manufacturing halls, highways and so on.

2N[®] Helios IP Uni is equipped with a loudspeaker (1 W). Thanks to an integrated acoustic echo cancelling (AEC) system, the product provides mutual audibility even of persons talking at the same time under normal conditions.

2N[®] Helios IP Uni can be provided with 1 or 2 pre-programmed buttons. You can set up to three telephone numbers and time profiles for each of the buttons to increase the accessibility of the called party.

2N[®] Helios IP Uni is equipped with an electric lock switch. You can control the switch during a call, using any telephone set.

2N[®] Helios IP Uni is very easy to install. All you have to do is connect the system into your LAN via a network cable and feed it from a 12 V power supply or your PoE supporting LAN.

Configure 2N[®] Helios IP Uni using your PC via any web browser. Use the 2N[®] Access Commander to manage extensive 2N[®] Helios IP Uni systems easily and quickly.

Advantages of Use

- Variable mounting options (brick/plasterboard flush mounting, wall mounting)
- Sensitive microphone and powerful loudspeaker
- Bidirectional communication - acoustic echo cancelling
- Optional dial buttons including name tags and backlight
- Integrated electronic lock switches with wide setting options
- LAN (PoE) or external 12 V power supply
- Configuration via web interface or dedicated PC application
- SIP 2.0 support
- HTTP server for configuration
- SNTP client for time synchronisation with server

1.1 Components and Associated Products

Basic Units

Part No. 9153101



- 1 button
- control of one electric lock
- protective switch

Part No. 9153102



- 2 buttons
- control of one electric lock
- protective switch

Part. No. 9153101P

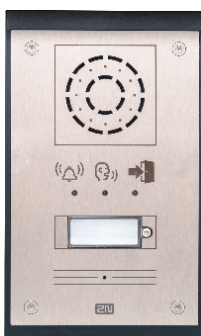

- 1 button, pictograms
- control of one electric lock
- protective switch

All **2N[®] Helios IP Uni** units can be flush mounted without requiring any additional accessories. Use the appropriate mounting box (see below) for wall (surface) mounting. **2N[®] Helios IP Uni** is designed for outdoor applications and requires no additional roof.

Mounting Accessories

Part No. 9153003



- Wall mounting box
- (Al casting)

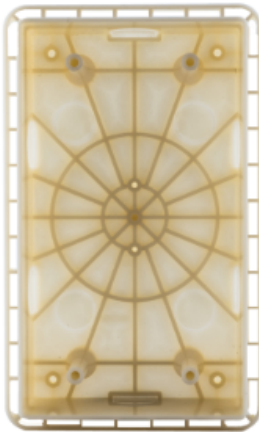

- Brick flush mounting box
- (included in the delivery)

Internal Units

Part Numbers:

91378365

91378366



- 2N[®] Indoor Touch - black
- WiFi version (second part no.)
- The elegant internal touch panel, 2N[®] Indoor Touch, is suitable for all 2N Helios IP intercoms. On the panel's display not only can you find out who is at the door, but also start a conversation with the visitor, open the lock or turn on the light in the entrance hall.

Part Numbers:

91378365WH

91378366WH



- 2N[®] Indoor Touch - white
- WiFi version (second part no.)
- The elegant internal touch panel, 2N[®] Indoor Touch, is suitable for all 2N Helios IP intercoms. On the panel's display not only can you find out who is at the door, but also start a conversation with the visitor, open the lock or turn on the light in the entrance hall.

VoIP Telephones

Part No. 91378357



- Grandstream GXV3240 VoIP video telephone
- GXV3240 is the successor to the popular GXV3140 model, which allows comfortable video calls in the IP network. Touchscreen and keyboard control.



Part No. 91378358



- Grandstream GXV3275 VoIP telephone
- GXV3275 is the successor to the popular GXV3175 model, which allows comfortable video calls in the IP network. Touchscreen control.

Electric Locks

<p>Part No. 932071E</p>  A silver-colored electric lock with a vertical handle and a rectangular body. It has two screws on the top and bottom of the body.	<ul style="list-style-type: none">• BEFO 1121• 12V/230mA DC• low consumption
<p>Part No. 932081E</p>  A silver-colored electric lock with a vertical handle and a rectangular body. It has two screws on the top and bottom of the body.	<ul style="list-style-type: none">• BEFO 11221 with momentum pin• 12V/230mA DC• low consumption• For opening of the lock a short electrical impuls is sufficient, which unlocks the lock. Lock is then open until someone closes the door.
<p>Part No. 932091E</p>  A silver-colored electric lock with a vertical handle and a rectangular body. It has two screws on the top and bottom of the body.	<ul style="list-style-type: none">• BEFO 11211MB with mechanical blocking• 12V/230mA DC• low consumption• Enables mechanically close or open the lock. When opened, the lock is open all the time. When closed, it behaves as standart electrical lock.

<p>Part No. 932061E</p> 	<ul style="list-style-type: none">• 211211 door signalling, low consumption• 12V / 230mA• A regular lock with a built-in contact to indicate whether the door is open or closed.
<p>Part No. 932072E</p> 	<ul style="list-style-type: none">• 31211 fail-safe• 12V / 170mA DC• The failsafe lock is closed when electricity is switched on. When electricity is interrupted, the lock is opened.
<p>Part No. 932062E</p> 	<ul style="list-style-type: none">• 321211 fail-safe, door signalling• 12V / 170mA• The failsafe lock is closed when electricity is switched on. When electricity is interrupted, the lock is opened.• It contains a built-in contact to indicate whether the door is open or closed.

✓ Tip

- FAQ: Electric locks - Difference between locks in 2N Helios IP accesories

Power Supply

<p>Part Numbers:</p> <p>91378100</p> <p>91378100E</p> <p>91378100US</p> 	<ul style="list-style-type: none"> • PoE injector - without cable • PoE injector - with EU cable • PoE injector - with US cable • For power supply of intercom via ethernet cable when PoE switch is not available.
<p>Part No. 91341481E</p> 	<ul style="list-style-type: none"> • Stabilised 12 V / 2 A power supply needs to be used when no PoE is available.
<p>Part No. 932928</p> 	<ul style="list-style-type: none"> • For external power supply of the lock with 12V AC voltage.

Additional Modules

<p>Part No. 9159010</p> 	<ul style="list-style-type: none"> • 2N® Helios IP Security Relay • A handy add-on that significantly enhances door entry security as it prevents tampering with the intercom and forced opening of the lock. To be installed between intercom and lock, powered by the intercom.
<p>Part No. 9159013</p> 	<ul style="list-style-type: none"> • Exit button • (suitable for Security relay) • A button for connection to a logic input for opening a door inside a building.
<p>Part No. 9159014EU/US /UK</p> 	<ul style="list-style-type: none"> • 2N® 2Wire • (set of 2 adaptors and power source for EU/US/UK) • The 2N® 2Wire converter allows you to use existing wiring (2 wires) from your original door bell or door intercom to connect any IP device. You don't have to configure anything, and you only need one 2N® 2Wire unit at each end of the cable and a power source connected to at least one of these units. The 2N® 2Wire unit then provides PoE power not only to the second converter, but also to all other connected IP end devices.

<p>Part No. 9159050</p>  A white rectangular device with a blue ear icon and the text '2N' and 'INDUCTION LOOP' on its surface.	<ul style="list-style-type: none">• 2N[®] Induction Loop• An induction loop transmits sound wirelessly from the 2N Helios IP intercom to the earphones of people with hearing disabilities and enables them to hear and perceive sounds better.
<p>Part No. 9159052</p>  A black power supply unit with a three-pronged AC plug and a cable with a DC connector.	<ul style="list-style-type: none">• Stabilised 12 V / 2 A power supply needs to be used when no PoE is available.
<p>Part No. 9159051</p>  A black square external antenna with a white ear icon and the text '2N' on its surface.	<ul style="list-style-type: none">• 2N[®] Induction loop - external antenna• External antenna boosts the range of usability of the induction loop, so that the disabled user can receive the audio signal in wider area. Use an external antenna with the induction loop, Part No. 9159050. A 170cm long interconnecting cable is included.

✔ **Tip**

- For more accessories and particular advice please contact your local distributor of 2N products.

1.2 Terms and Symbols

The following symbols and pictograms are used in the manual:

Safety

- Always abide by this information to prevent persons from injury.

Warning

- Always abide by this information to prevent damage to the device.

Caution

- Important information for system functionality.

Tip

- Useful information for quick and efficient functionality.

Note

- Routines or advice for efficient use of the device.

2. Description and Installation

Here is what you can find in this section:

- 2.1 Before You Start
- 2.2 Mechanical Installation
- 2.3 Electric Installation
- 2.4 Button Tags
- 2.5 Extending Module Connection

Product Completeness Check

Before you start please check the contents of your 2N[®] Helios IP Uni delivery:

- 1× 2N[®] Helios IP Uni
- 1× Torx 10 / Torx 20 double-ended wrench
- 1× 2N[®] Helios IP Uni Installation Manual
- 1× mounting template
- 1× A5 transparent name plate foil
- 1× spare name plate
- 1× brick flush mounting box
- 4× (4 × 12) mm stainless steel, torx screws for plastics
- 2× cable ties

2.2 Mechanical Installation

Content

Common Mounting Principles

Flush Mounting - Classic Bricks

Flush Mounting - Plasterboard

Wall Mounting

Common Mounting Principles

Tip

- Select flush mounting where possible to make your product elegant looking, more vandal resistant and more secure.

Caution

- Stainless steel screws are used for the 2N[®] Helios IP Uni assembly. Other screws than stainless steel ones corrode soon and may aesthetically deteriorate the surrounding environment!
- Having removed the front panel, make sure that no dirt gets inside the product (especially onto the sealing surface).

⚠ Caution

- The warranty does not apply to the product defects and failures arisen as a result of improper mounting (in contradiction herewith). The manufacturer is neither liable for damage caused by theft within an area that is accessible after the attached electric lock is switched. The product is not designed as a burglar protection device except when used in combination with a standard lock, which has the security function.
- When the proper mounting instructions are not met, water might get in and destroy the electronics. It is because the intercom circuits are under continuous voltage and water infiltration causes an electro-chemical reaction. The manufacturer's warranty shall be void for products damaged in this way!

Flush Mounting – Classic Bricks

- (including hollow bricks, thermally insulated walls, etc.)

What you need:

- A properly cut hole
- Plaster, mounting glue, mounting foam or mortar as necessary

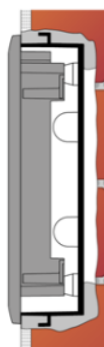

1. Cut a wall hole using the template enclosed. Make sure that all the required cables are available in the hole.
2. Unpack the plastic mounting box. Break out the cable holes as necessary and make sure that the wall hole is big enough for the box.
3. Wall up the mounting box making sure that the box is aligned with the wall surface. Wait until the plaster (mortar, mounting foam, etc.) sets.
4. Unscrew the front panel from the door intercom.

5. Connect the cables to the terminals or RJ connector as described in the **Electric Connection** subsection.
6. You can use the cable tie for connection as shown:

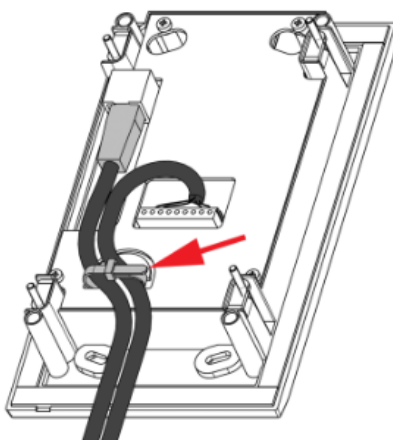

Mounting completion - after electric installation!

7. Insert the intercom in the mounting box in the wall.
8. Tighten the intercom with the stainless steel screws included in the delivery. As the screw holes are oval, you can perfect the vertical position before tightening.
9. We do not recommend you to insert the button tags now.
10. Replace the stainless steel front panel fixing it with the stainless steel screws you unscrewed in step 4 above.
11. Seal the top and lateral sides carefully with some cement or non-aggressive silicone to avoid water infiltration.

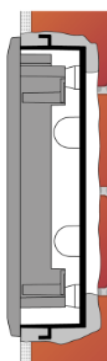

Make sure that the installation hole has the required dimensions for flush mounting. Dimensions are shown at the following picture.

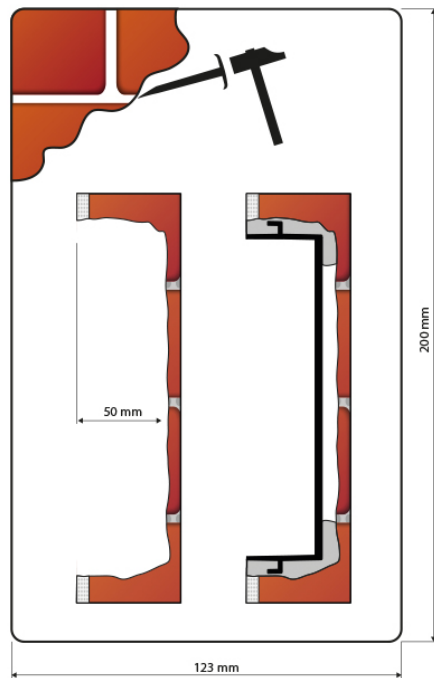

Hole dimensions for flush mounting

Flush Mounting - Plasterboard

What you need:

- Just a properly cut hole

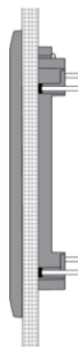

 **Tip**

- If this is your first plasterboard installation, check the function of the intercom side clamps. Loosen and then re-tighten the clamp screw to see how it turns automatically and starts moving forwards in its slot. Remember to return the clamp into the original position after the check!

 **Caution**

- Check the plasterboard wall and room interior pressure values (caused, e. g., by overpressure ventilation). If the difference between the values is too great, separate the intercom using, for example, the mounting box enclosed and seal the cable passage to avoid loudspeaker damage.

1. Cut a hole 100 (W) × 180 (H) mm.
2. Unscrew the front panel from the door intercom.
3. Connect the cables in the hole to the terminals or RJ connector as described in the **Electric Connection subsection Mounting completion - after electric installation!**
4. Insert the intercom in the hole keeping it in the vertical position.
5. Loosen the four clamp screws one after another and then retighten them slowly. They will turn aside automatically and start moving forwards in their slots. You need about **10 turns** to tighten the clamps completely. You can perfect the vertical position before final tightening of the screws.
6. We do not recommend you to insert the button tags now.
7. Replace the stainless steel front panel fixing it with the stainless steel screws you unscrewed in step 2.

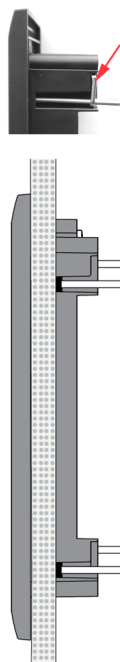

Wall Mounting

- (concrete and steel structures, entry barrier columns, etc.)

What you need:

- Wall mounting box Part No. **9153003**

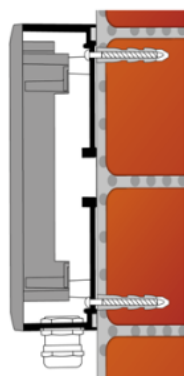

The 2N[®] Helios IP Uni AI box, (Part No. **9153003**) is designed for wall mounting especially where flush mounting is impossible such as on carrier elements of industrial objects.

Mounting instructions:

1. a) If the cable wall outlets are located directly under the intercom to be installed, move the cap from the middle hole to the bottom one to make way for the cables. Make sure that no water can get into the intercom through the middle hole! The best solution is to seal the hole perfectly with silicone, for example.
b) If the cables lead along the wall below the intercom level, put the template to the wall in its normal position – the bushing will be on the bottom side.
c) If the cables lead along the wall above the intercom level, put the template to the wall reversely – the bushing will be on the upper side.
2. Use an 8 mm drill to drill two holes of the minimum depth of 50 mm with the aid of the template.
3. Push the dowels into the holes and attach the box and screws. Perfect the box position using the oval holes before tightening the screws completely.
4. Connect the cables to the intercom as instructed.
5. Mount the intercom without the front panel to the box using the M4 screws included in the delivery.
6. Screw the front panel onto the intercom.
7. Tighten the cable bushing properly to fix the cables especially where the bushing is on the upper box side to avoid water leakage!

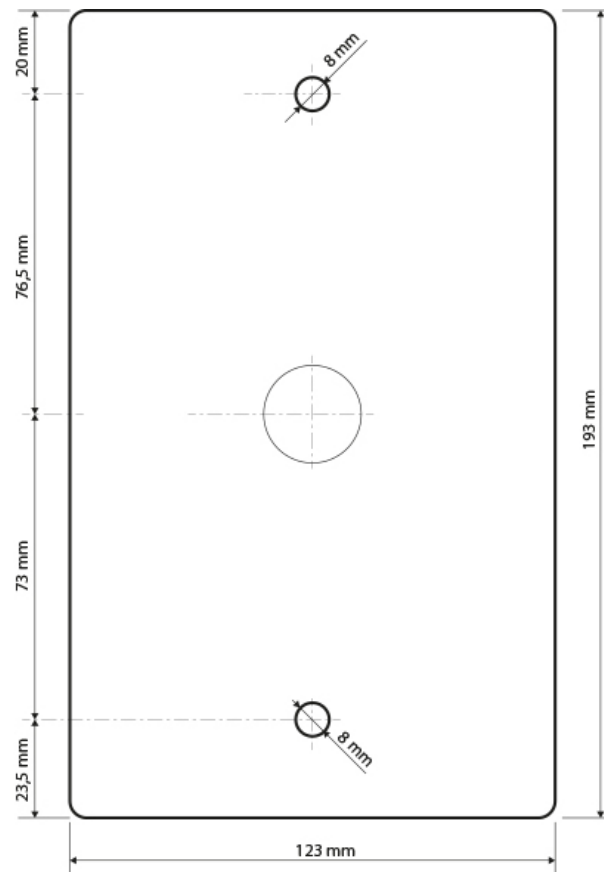

Dimension for wall (surface) mounting

2.3 Electric Installation

This subsection describes how to connect 2N[®] Helios IP Uni into your Local Area Network (LAN) and how to connect supply voltage and the electric lock.

PCB Connectors

Description of Connectors

- LAN - LAN connector
- OUT1 - Active switched output
- RELAY1 - Relay NO/NC contacts
- TAMPER - Tamper switch
- POWER - Power input
- RESET - RESET button

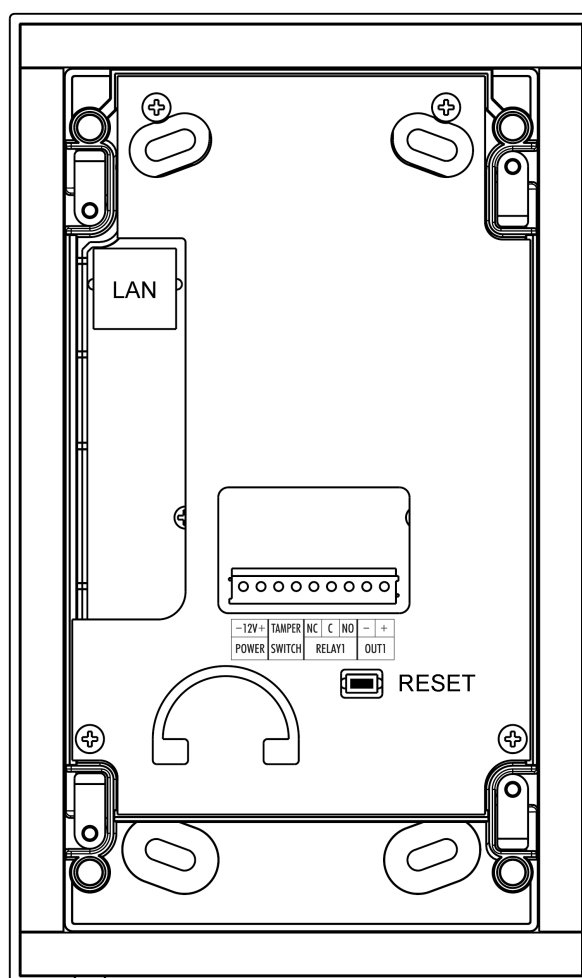

LAN Connection

2N[®] Helios IP Uni is connected to the LAN via a RJ-45 terminated (connector LAN) UTP/STP cable (of category Cat 5e or higher). The system is equipped with the Auto-MDIX function and so both the straight and crossed cable versions can be used

Caution

- We recommend the use of a LAN surge protection.

External Power Supply Connection

2N[®] Helios IP Uni can be fed either from an external 12 V / 2 A DC power supply or from the LAN equipped with the PoE 802.3af supporting network elements.

External Power Supply

An external 12 V power supply is connected to terminal block POWER. Use a 12 V \pm 15 % DC power source dimensioned to current intake of 2 A at least (Part No. 91341481E) to ensure a reliable function of your device.

PoE Supply

2N[®] Helios IP Uni is compatible with the PoE 802.3af (Class 0 - 12,95 W) technology and can be supplied directly from the LAN via compatible network elements. If your LAN is incompatible, insert the PoE injector, Part No. **91378100E/US**, between 2N[®] Helios IP Uni and the nearest network element.

Electric Lock Connection

2N[®] Helios IP Uni is equipped with an electrically isolated relay switch with NO and NC contacts (terminal block RELAY1, up to 30 V / 1 A AC/DC) and 8 up to 12 V DC depending on power supply (PoE: 9 V; adaptor: power supply voltage minus 2 V), max 500 mA, switched output (terminal block OUT1), to which a standard electric lock or another compatible electrical appliance can be connected.

Note

- Both outputs OUT1 and RELAY1 are switched always simultaneously.

Warning

When you connect a device containing a coil, such as a relay or an electromagnetic lock, it is necessary to protect the intercom against voltage peak while switching off the induction load. For this way of protection we recommend a diode 1A / 1000V (e.g., 1N4007, 1N5407, 1N5408) connected antiparallel to the device.

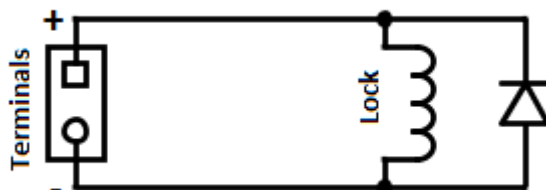
**Tamper Switch Connection**

2N[®] Helios IP Uni is equipped with a tamper switch for detection of unauthorized penetration into the device. After correct and complete installation of the device the tamper switch is closed. Tamper switch opens immediately when the front panel is removed. Tamper switch contacts are available on terminal block TAMPER SWITCH.

Device Resetting

2N[®] Helios IP Uni is equipped with a RESET button. Push the button for more than 10 s to reset the factory default values, deleting all the data stored in the device. Push the button shortly (< 1 s) to restart the device without changing its configuration.

2.4 Button Tags

This subsection describes work with Button Tags in 2N[®] Helios IP Uni.

Tag Printing

1. Every 2N[®] Helios IP Uni delivery includes a sheet of translucent foil, which can be laser-printed. Cut the printed foil and insert the tags in the name plates (template for printing is available in section Downloads).
2. Every name plate includes a piece of foil, which can be written over manually, using a waterproof permanent marker, if necessary.

Note

- Always use waterproof foil (enclosed or other) for the tags. Never use paper or ink jet printing to avoid damage due to water leakage!

Tag Inserting/Replacing Instructions

2N[®] Helios IP Uni provides an intuitive, easy access to the name plates. The tags are easy to insert and replace even without a manual. You need not remove the front panel and thus are not exposed to the risk of loss of components while replacing the tags.

1. Loosen the name plate screw using the wrench enclosed, for example. You can open the name plate window like a door without losing the tightened screw.
2. Remove the used or blank name tag and insert a new tag.
3. Close the name plate window and tighten the screw appropriately.
4. Check the click effect of the buttons: if the button fails to click properly when pressed (when moved by approx. 0.5 mm), the tag is too thick or thin. Make sure that the button clicks when you press it on either end.

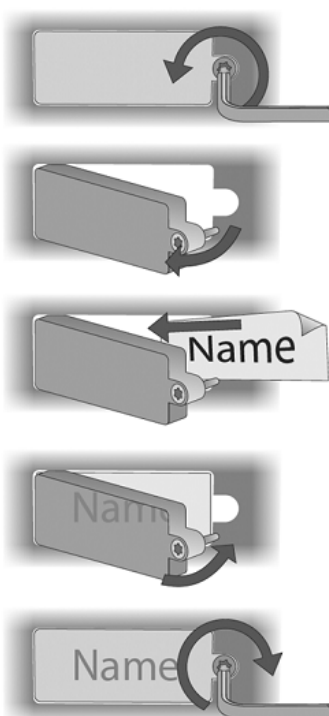

2.5 Extending Module Connection

2N[®] Helios IP Uni allows to connect following extending modules:

- Security Relay
- Induction Loop

Security Relay

The **Security Relay** (Part No. 9159010) is used for enhancing security between the intercom and the connected electric lock. The **2N[®] Helios IP Security Relay** is designed for any **2N Helios IP** intercom model with firmware versions 1.15 and higher. It significantly enhances security of the connected electric lock as it prevents lock opening by forced intercom tampering.



Function:

The **2N[®] Helios IP Security Relay** is a device installed between an intercom (outside the secured area) and the electric lock (inside the secured area). The **2N[®] Helios IP Security Relay** includes a relay that can only be activated if the valid opening code is received from the intercom.

Specifications:

- Passive switch: NO and NC contacts, up to 30 V / 1 A AC/DC
- Active switch output: 9 up to 13 V DC depending on power supply (PoE: 9 V; adaptor: power supply voltage minus 1 V), max 700 mA
- Dimensions: (56 × 31 × 24) mm
- Weight: 20 g

Installation:

Install the 2N[®] Helios IP Security Relay onto a two-wire cable between the intercom and the electric lock inside the area to be secured (typically behind the door). The device is powered and controlled via this two-wire cable and so can be added to an existing installation. Thanks to its compact dimensions, the device can be installed into a standard mounting box.

Connection:

Connect the 2N[®] Helios IP Security Relay to the intercom as follows:

- To the intercom active output (OUT1), or
- To the intercom relay output (RELAY1) with a 12 V DC serial external power supply.

Connect the electric lock to the 2N[®] Helios IP Security Relay output as follows:

- To the active 12 V / 700 mA DC output, or
- To the relay output with a serial external power supply.

The device also supports a Departure button connected between the 'PB' and '- HeliosIP' terminals. Press the Departure button to activate the output for 5 seconds.

Status signalling:

Green LED	Red LED	Status
blinking	off	Operational mode
on	off	Activated output
blinking	blinking	Programming mode - waiting for initialisation
on	blinking	Error - wrong code received

Configuration:

- Connect the 2N[®] Helios IP Security Relay to the properly set intercom switch output; refer to the **Configuration Manual**. Make sure that one LED at least on the 2N[®] Helios IP Security Relay is on or blinking.
- Press and hold the 2N[®] Helios IP Security Relay Reset button for 5 seconds to put the device in the programming mode (both the red and green LEDs are blinking).
- Activate the intercom switch using the keypad, telephone, etc. The first code sent from the intercom will be stored in the memory and considered valid. After code initialisation, the 2N[®] Helios IP Security Relay will pass into the operational mode (the green LED is blinking).

✔ Tip

- [FAQ: 2N[®] Helios IP Security Relay - what it is and how to use it with 2N Helios IP intercom?](#)

✔ Tip

- [Video Tutorial: Door intercoms 2N[®] Helios IP - Security Relay](#)

Connection:

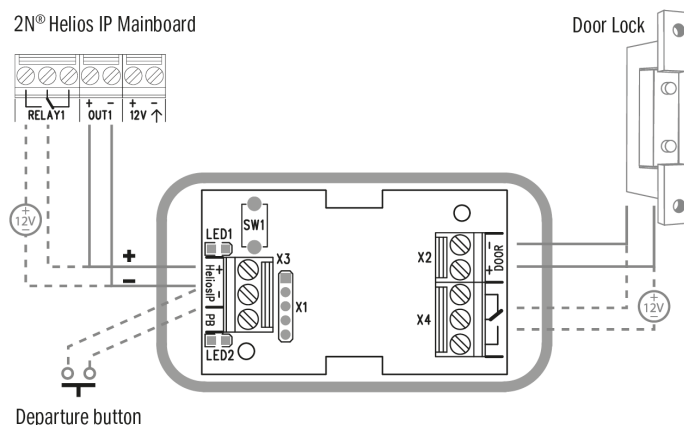

Induction Loop

2N[®] Induction Loop (Part No. 9159050 – Induction loop amplifier for 2N Helios intercom, Part No. 9159054 – Induction loop amplifier without Helios accessory, Part No. 9159051 – External induction loop for wall mounting, Part No. 9159052 – 12 V DC power adapter) is part of sound system installations for hearing impaired persons that are equipped with a special hearing aid capable of receiving reproduced sound via a magnetic field receiver. The system is defined by the IEC 60118-4 standard.

Installation:

The induction loop amplifier can be wall mounted with the use of an internal induction loop where a signal covering is requested. Outdoor use is possible thanks to the IP65 covering. A four-wire cable of the length of one meter is mounted to the supplied product for easier connection to the intercom. In the cable are two wires for 12 V DC supply and two wires for signal input, the wires are connected into interconnection connector. If you shorten the cable, follow the colour marking.

Before wall mounting run the cable through the hole that you have prepared. Then mark two mounting holes on the wall, through the amplifier front. Remove the amplifier and drill the mounting holes. Use the plugs and screws included in the delivery. Use a drill of the diameter of 6 mm. After fastening, cover the screws with the blanks supplied.

Use the supplied connectors to connect the amplifier to the intercom and power supply. The A connector is connected to the amplifier four-wire cable. Insert a special intercom-connecting cable supplied with the amplifier and 12 V power supply outlets to the B connector. Connect the special cable to the intercom and connect the power supply to the mains. You can place the mated A and B connectors into the 2N[®] Helios

cover. The connectors help you connect stripped cables. Open the connector by pushing a thin screwdriver onto the white spots at its front and close the connector by sliding the movable part through a side gap.

Finally, test the amplifier function using a suitable receiver for hearing impaired persons or magnetic field communication tester. No other settings are required.

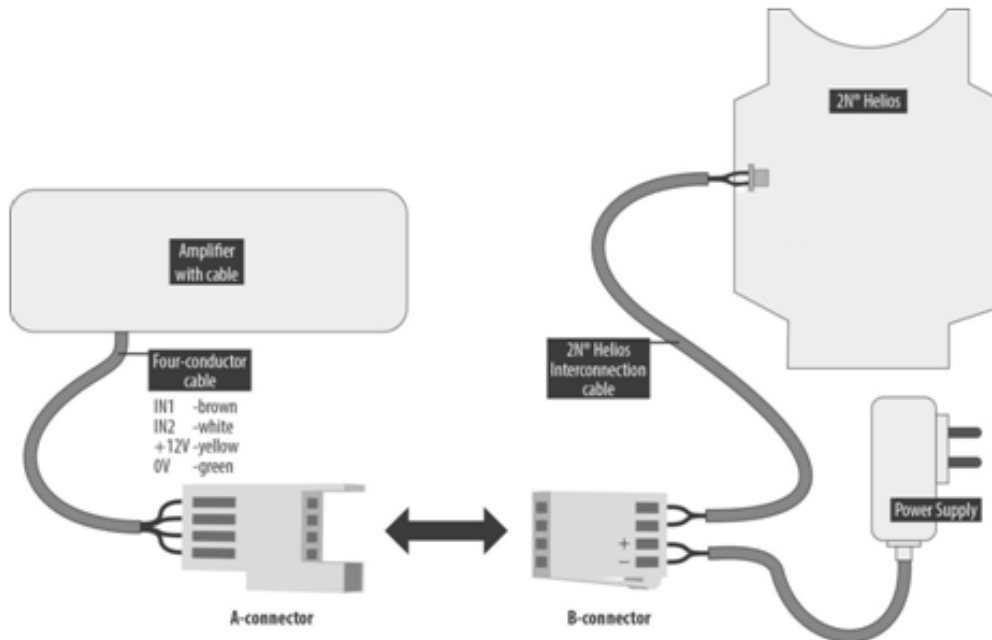

Specifications:

- Supply voltage: 8 – 18VDC
- Supply current at 12 V supply:
 - 1 Ω load, full power output; 1.4 A, sine wave signal; 1 A, pink noise signal
 - 8 Ω load, half power output; 550 mA, sine wave signal; 400 mA, pink noise signal
 - no signal; 100 mA
 - standby; up to 10 mA
- Transition to standby w/o signal: 10 s
- Input level - basic: 100 mV – 6 V_{rms}
- Input level - increased: 1 V – 35 V_{rms}
- Input impedance: 2 k Ω parallel with 0.3 H
- Output current, 1 Ω load: 2.2 A_{rms} (sine wave)
- Full power output: 1.6 A_{rms} (pink noise)
- Output current, 8 Ω load: 730 mA_{rms} sine wave signal

-
- Half power output: 520 mA_{rms} pink noise signal
 - Output short-circuit resistance: unlimited time
 - Frequency characteristics: 100 Hz - 5KHz \pm 3 dB
 - Temperature range: -20 - +50 °C
 - Covering: IP65 (with round cable of 5 - 10 mm diameter)
 - Dimensions: 144 x 100 x 31 mm
 - Weight: 0.3 kg

3. Function and Use

In this section we describe the basic and extending functions of the 2N[®] Helios IP Uni product.

Here is what you can find in this section:

- **3.1 Configuration**
- **3.2 Control**
- **3.3 Maintenance**
- **3.4 Downloads**

3.1 Configuration

2N[®] Helios IP Uni Use a PC equipped with any web browser to configure:

- Launch your web browser (Internet Explorer, Firefox, etc.).
- Enter the IP address of your intercom (<http://192.168.1.100/>, e.g.).
- Log in using the **Admin** user name and **2n** password.

You have to know the IP address of your device to log in to the integrated web server.

By default, **2N[®] Helios IP Uni** is switched into the dynamic IP address mode, i.e. it obtains the IP address automatically if a properly set DHCP server is available in your LAN. If no such DHCP server is available, you can operate **2N[®] Helios IP Uni** in the static IP address mode.

If your device remains inaccessible (you have forgotten the IP address, or the LAN configuration has changed, for example), change the LAN settings using the buttons on the device.

IP Address Retrieval

Take the following steps to retrieve the **2N[®] Helios IP Uni** IP address:

- Connect (or, if connected, disconnect and reconnect) **2N[®] Helios IP Uni** to the power supply.
- Wait for the second sound signal .
- Press the quick dial button 5 times.
- **2N[®] Helios IP Uni** will read its IP address.
- If the address is 0.0.0.0, it means that the intercom has not obtained the IP address from the DHCP server.

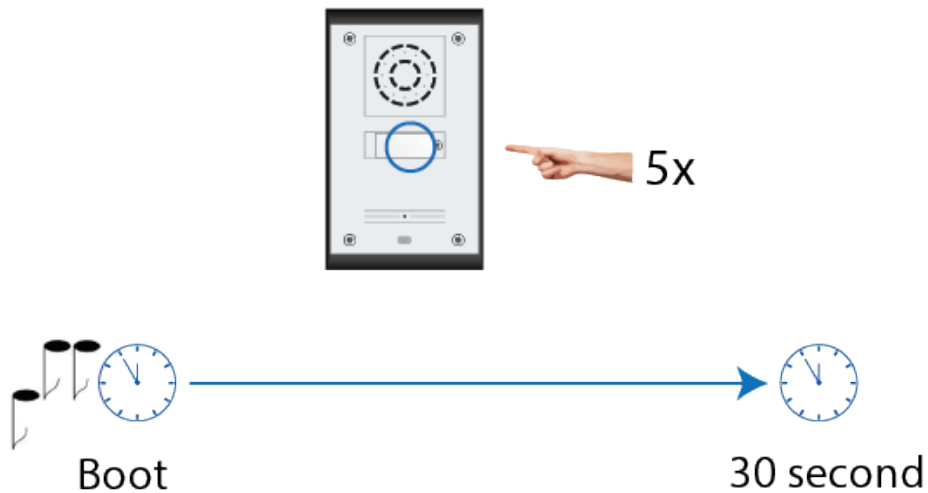

Note

- Be sure to press the button sequence within thirty seconds after the sound signal for security reasons. Up to 2 s intervals are allowed between the presses.

Static/Dynamic Address Setting Mode Switching

In case your 2N[®] Helios IP Uni device is equipped with 1 or 2 buttons, you can switch the modes using one button only.

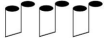
- Connect 2N[®] Helios IP Uni to the power supply (or, disconnect and reconnect it if already connected).
- Wait for the first acoustic signal .
- Press the quick dial button 15 times.
- The acoustic signal  indicates mode switching.
- Wait until the device is restarted automatically.

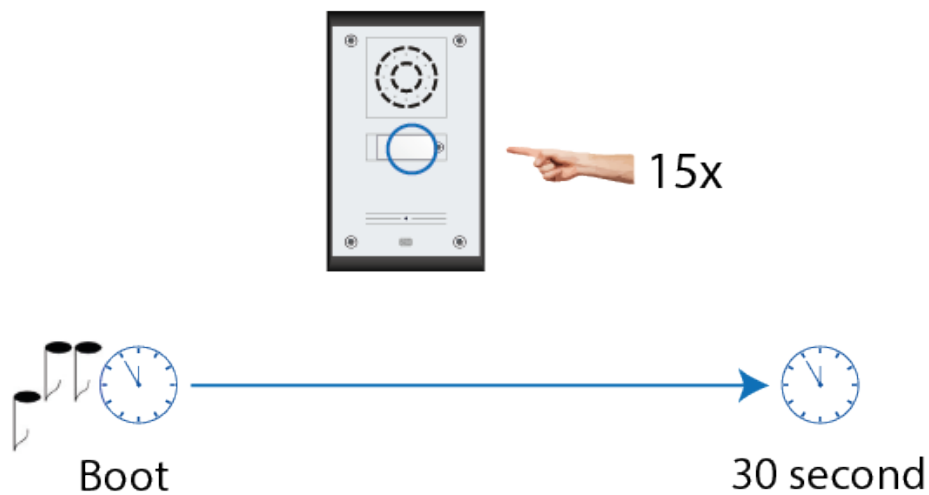

Caution

- The 15 times 1 sequence must be entered within 30 seconds after the first sound signal for security reasons. The inter-digit delay may be 2 s at most.

The static IP address mode will be switched into the dynamic IP address mode and vice versa upon restart.

3.2 Control

This subsection describes how to control 2N[®] Helios IP Uni when viewed by an external user.

Speed Dial Buttons

Press the speed dial buttons on the basic unit to make quick dialling for the first 1 or 2 (depending on the model type) in the telephone directory. Call setup is signalled by a long intermittent tone or otherwise as configured in the PBX connected.

Repeated pressing of one and the same speed dial button during call setup may initiate call termination, or call termination plus dialling the next telephone number of the called subscriber, or may be assigned no function.

3.3 Maintenance

Cleaning

If used frequently, the device surface gets dirty. To clean it, use a piece of soft cloth moistened with clean water. We recommend you to follow these principles while cleaning:

- Never use aggressive detergents (such as abrasives or strong disinfectants)
- Alcohol-based cleaners may be applied.
- Clean the device in dry weather in order to make waste water evaporate quickly.
- We recommend using cleaning wipes designed for IT / electronic items.

Future Tag Replacement, Programming Changes

For necessary steps refer to the preceding subsections. Keep the following for future changes:

- This manual
- Unused transparent foil strips for button tags

Caution

- Always use the product for the purpose it was designed and manufactured for, in compliance herewith.
- The manufacturer reserves the right to modify the product in order to improve its qualities.
- **2N[®] Helios IP Uni** contains no environmentally harmful components.

When the product's service life is exhausted and you would like to dispose of it please do so in accordance with applicable legal regulations.

3.4 Downloads

Templates

Nametags

Software

2N[®] Helios IP network scanner 3.0.4

4. Technical Parameters

Signalling protocol

- SIP (UDP, TCP, TLS)

Buttons

- **Button design:** Transparent, white backlit buttons with easily replaceable name tags
- **Button count:** 1 or 2

Audio

- **Microphone:** 1 integrated microphone
- **Amplifier:** 1 W (class D)
- **Loudspeaker:** 1 W
- **Sound pressure level (SPL max):** 77.5 dB (for 1 kHz, distance 1 m)
- **Volume control:** Adjustable with automatic adaptive mode
- **Full duplex:** Yes (AEC)

Audio stream

- **Protocols:** RTP/RTSP
- **Codecs:** G.711

Interfaces

- **Power supply:** 12 V \pm 15 % / 2 A DC or PoE
- **PoE:** PoE 802.3af (Class 0 - 12.95 W)
- **LAN:** 10/100BASE-TX s Auto-MDIX, RJ-45
- **Recommended cabling:** Cat-5e or higher
- **Passive switch:** NO and NC contacts, up to 30 V / 1 A AC/DC
- **Active switch output:** 8 up to 12 V DC depending on power supply (PoE: 9 V; adaptor: power supply voltage minus 2 V), max 500 mA

Mechanical properties

- **Cover:** ABS plastic, high-quality stainless steel
- **Working temperature:** -40 °C to 55 °C
- **Working relative humidity:** 10 % to 95 % (non-condensing)
- **Storing temperature:** - 40 °C to 70 °C
- **Dimensions**
 - (193 × 115 × 39) mm
 - (197 × 119 × 47) mm with flush mounting box
 - (193 × 115 × 57) mm for wall mounting
- **Weight**
 - Product net weight: 500 g
 - Mounting box: 135 g
 - Total weight incl. package: 800 g
- **Covering level:** IP54

5. Supplementary Information

Here is what you can find in this section:

- 5.1 Troubleshooting
- 5.2 Directives, Laws and Regulations
- 5.3 General Instructions and Cautions

5.1 Troubleshooting



For the most frequently asked questions refer to faq.2n.cz.

5.2 Directives, Laws and Regulations

Europe

2N[®] Helios IP Uni conforms to the following directives and regulations:

Directive 1999/5/EC of the European Parliament and of the Council, of 9 March 1999 - on radio equipment and telecommunications terminal equipment and the mutual recognition of their conformity

Directive 2006/95/EC of the European Parliament and of the Council of 12 December 2006 on the harmonisation of the laws of Member States relating to electrical equipment designed for use within certain voltage limits

Directive 2004/108/EC of the Council of 15 December 2004 on the harmonisation of the laws of Member States relating to electromagnetic compatibility

Commission Regulation (EC) No. 1275/2008, of 17 December 2008, implementing Directive 2005/32/EC of the European Parliament and of the Council with regard to ecodesign requirements for standby and off mode electric power consumption of electrical and electronic household and office equipment

Directive 2011/65/EU of the European Parliament and of the Council of 8 June 2011 on the restriction of the use of certain hazardous substances in electrical and electronic equipment

Regulation (EC) No. 1907/2006 of the European Parliament and of the Council of 18 December 2006 concerning the Registration, Evaluation, Authorisation and Restriction of Chemicals (REACH), establishing a European Chemicals Agency, amending Directive 1999/45/EC and repealing Council Regulation (EEC) No. 793/93 and Commission Regulation (EC) No. 1488/94 as well as Council Directive 76/769/EEC and Commission Directives 91/155/EEC, 93/67/EEC, 93/105/EC and 2000/21/EC

Directive 2012/19/EC of the European Parliament and of the Council of 4 July 2012 on waste electrical and electronic equipment.

Industry Canada

This Class B digital apparatus complies with Canadian ICES-003. / Cet appareil numérique de la classe B est conforme à la norme NMB-003 du Canada.

FCC

NOTE: This equipment has been tested and found to comply with the limits for a Class B digital device, pursuant to part 15 of the FCC Rules. These limits are designed to provide reasonable protection against harmful interference in a residential installation.

This equipment generates, uses and can radiate radio frequency energy and, if not installed and used in accordance with the instructions, may cause harmful interference to radio communications. However, there is no guarantee that interference will not occur in a particular installation. If this equipment does cause harmful interference to radio or television reception, which can be determined by turning the equipment off and on, the user is encouraged to try to correct the interference by one or more of the following measures:

- Reorient or relocate the receiving antenna
- Increase the separation between the equipment and receiver
- Connect the equipment into an outlet on a circuit different from that to which the receiver is connected
- Consult the dealer or an experienced radio/TV technician for help.

Changes or modifications to this unit not expressly approved by the party responsible for compliance could void the user's authority to operate this equipment.

5.3 General Instructions and Cautions

Please read this User Manual carefully before using the product. Follow all instructions and recommendations included herein.

Any use of the product that is in contradiction with the instructions provided herein may result in malfunction, damage or destruction of the product.

The manufacturer shall not be liable and responsible for any damage incurred as a result of a use of the product other than that included herein, namely undue application and disobedience of the recommendations and warnings in contradiction herewith.

Any use or connection of the product other than those included herein shall be considered undue and the manufacturer shall not be liable for any consequences arisen as a result of such misconduct.

Moreover, the manufacturer shall not be liable for any damage or destruction of the product incurred as a result of misplacement, incompetent installation and/or undue operation and use of the product in contradiction herewith.

The manufacturer assumes no responsibility for any malfunction, damage or destruction of the product caused by incompetent replacement of parts or due to the use of reproduction parts or components.

The manufacturer shall not be liable and responsible for any loss or damage incurred as a result of a natural disaster or any other unfavourable natural condition.

The manufacturer shall not be held liable for any damage of the product arising during the shipping thereof.

The manufacturer shall not make any warrant with regard to data loss or damage.

The manufacturer shall not be liable and responsible for any direct or indirect damage incurred as a result of a use of the product in contradiction herewith or a failure of the product due to a use in contradiction herewith.

All applicable legal regulations concerning the product installation and use as well as provisions of technical standards on electric installations have to be obeyed. The manufacturer shall not be liable and responsible for damage or destruction of the product or damage incurred by the consumer in case the product is used and handled contrary to the said regulations and provisions.

The consumer shall, at its own expense, obtain software protection of the product. The manufacturer shall not be held liable and responsible for any damage incurred as a result of the use of deficient or substandard security software.

The consumer shall, without delay, change the access password for the product after installation. The manufacturer shall not be held liable or responsible for any damage incurred by the consumer in connection with the use of the original password.

The manufacturer also assumes no responsibility for additional costs incurred by the consumer as a result of making calls using a line with an increased tariff.

Electric Waste and Used Battery Pack Handling



Do not place used electric devices and battery packs into municipal waste containers. An undue disposal thereof might impair the environment!

Deliver your expired electric appliances and battery packs removed from them to dedicated dumpsites or containers or give them back to the dealer or manufacturer for environmental-friendly disposal. The dealer or manufacturer shall take the product back free of charge and without requiring another purchase. Make sure that the devices to be disposed of are complete.

Do not throw battery packs into fire. Battery packs may not be taken into parts or short-circuited either.



2N TELEKOMUNIKACE a.s.

Modřanská 621, 143 01 Prague 4, Czech Republic

Phone: +420 261 301 500, Fax: +420 261 301 599

E-mail: sales@2n.cz

Web: www.2n.cz

v2.7