

Grandstream Networks, Inc.

HT802 Analog Telephone Adaptor

Administration Guide



COPYRIGHT

©2016 Grandstream Networks, Inc. <http://www.grandstream.com>

All rights reserved. Information in this document is subject to change without notice. Reproduction or transmittal of the entire or any part, in any form or by any means, electronic or print, for any purpose without the express written permission of Grandstream Networks, Inc. is not permitted.

The latest electronic version of this user manual is available for download here:

<http://www.grandstream.com/support>

Grandstream is a registered trademark and Grandstream logo is trademark of Grandstream Networks, Inc. in the United States, Europe and other countries.

CAUTION

Changes or modifications to this product not expressly approved by Grandstream, or operation of this product in any way other than as detailed by this User Manual, could void your manufacturer warranty.

WARNING

Please do not use a different power adaptor with your devices as it may cause damage to the products and void the manufacturer warranty.



GNU GPL INFORMATION

HT802 firmware contains third-party software licensed under the GNU General Public License (GPL). Grandstream uses software under the specific terms of the GPL. Please see the GNU General Public License (GPL) for the exact terms and conditions of the license.

Grandstream GNU GPL related source code can be downloaded from Grandstream web site from:

<http://www.grandstream.com/support/faq/gnu-general-public-license/gnu-gpl-information-download>



Table of Content

DOCUMENT PURPOSE	6
CHANGE LOG	7
Firmware Version 1.0.3.2.....	7
Firmware Version 1.0.2.7.....	7
Firmware Version 1.0.2.5.....	7
Firmware Version 1.0.2.3.....	7
Firmware Version 1.0.1.9.....	7
GUI INTERFACE EXAMPLES.....	8
WELCOME	9
PRODUCT OVERVIEW	10
Feature Highlights.....	10
HT802 Technical Specifications.....	10
GETTING STARTED.....	12
Equipment Packaging.....	12
HT802 Ports Description.....	12
Connecting HT802.....	13
HT802 LEDs Pattern.....	13
CONFIGURATION GUIDE.....	15
Obtain HT802 IP Address via Connected Analogue Phone	15
Understanding HT802 Interactive Voice Prompt Response Menu	15
Configuration via Web Browser	17
<i>Accessing the Web UI</i>	<i>17</i>
<i>Web UI Access Level Management.....</i>	<i>17</i>
<i>Saving the Configuration Changes.....</i>	<i>17</i>
<i>Changing Admin Level Password.....</i>	<i>18</i>
<i>Changing User Level Password</i>	<i>18</i>
<i>Changing HTTP Web Port</i>	<i>18</i>
Web Configuration Pages Definitions	19
<i>Status Page Definitions</i>	<i>19</i>
<i>Basic Settings Page Definitions.....</i>	<i>20</i>
<i>Advanced Settings Page Definitions</i>	<i>22</i>
<i>FXS Port (1,2) Pages Definitions.....</i>	<i>27</i>
NAT Settings	38
DTMF Methods	38



Preferred Vocoder (Codec).....	39
Configuring HT802 Through Voice Prompts.....	39
Register a SIP Account.....	39
Call Features.....	41
Rebooting HT802 from Remote.....	42
UPGRADING AND PROVISIONING	43
Firmware Upgrade procedure.....	43
Upgrading via Local Directory:.....	44
Upgrading via Local TFTP/HTTP Servers	44
Firmware and Configuration File Prefix and Postfix	44
Managing Firmware and Configuration File Download.....	45
Configuration File Download.....	45
RESTORE FACTORY DEFAULT SETTINGS	46
Using the Reset Button.....	46
Using the IVR Command.....	46
Reset from Web Interface (Reset Type)	47
EXPERIENCING HT802	48

Table of Tables

Table 1: HT802 Features at a Glance	10
Table 2: HT802 Technical Specifications	10
Table 3: Definition of the HT802 Connectors	13
Table 4: HT802 LEDs Pattern Description	14
Table 5: Voice Prompt Menu	15
Table 6: Status Page Definitions	19
Table 7: Basic Settings Page	20
Table 8: Advanced Settings.....	22
Table 9: FXS Port (1,2).....	27
Table 10: HT802 Call Features	41

Table of Figures

Figure 1: HT802 Package Contents.....	12
Figure 2: HT802 Back Panel	12
Figure 3: Connecting the HT802.....	13
Figure 4: HT802 LEDs Pattern.....	14
Figure 5: Admin Level Password	18
Figure 6: User Level Password	18
Figure 7: Web HTTP Port.....	19
Figure 8: SIP Accounts Settings.....	40
Figure 9: Account Status	41
Figure 10: Firmware Upgrade Page.....	43



DOCUMENT PURPOSE

This document describes the basic concept and tasks necessary to use and configure your HT802. And it covers the topic of connecting and configuring the HT802, making basic operations and the call features. Please visit <http://www.grandstream.com/support> to download the latest “HT802 User Guide”.

This guide covers following topics:

- [Product overview](#)
- [Getting started](#)
- [Configuration guide](#)
- [Upgrade and provisioning](#)
- [Restore factory default settings](#)



CHANGE LOG

This section documents significant changes from previous versions of administration guide for HT802. Only major new features or major document updates are listed here. Minor updates for corrections or editing are not documented here.

Firmware Version 1.0.3.2

- Added option “DNS SRV use Registered IP” [DNS SRV use Registered IP]
- Changed default NTP server from us.pool.ntp.org to pool.ntp.org [NTP Server]

Firmware Version 1.0.2.7

- No major changes

Firmware Version 1.0.2.5

- Changed OPUS Payload Type default value to 123 to match other GS products. [OPUS Payload Type]

Firmware Version 1.0.2.3

- Added a re-enter box to confirm change user and admin password on web GUI to avoid typo or mistakes. [Confirm Admin Password][Confirm End User Password]
- Add new iLBC libraries to improve iLBC audio quality.

Firmware Version 1.0.1.9

- This is the initial version for HT802.



GUI INTERFACE EXAMPLES

http://www.grandstream.com/sites/default/files/Resources/ht802_web_gui.zip

1. Screenshot of Login Page
2. Screenshots of Status Page
3. Screenshots of Basic Settings Page
4. Screenshots of Advanced Settings Page
5. Screenshots of FXS Port 1 Page
6. Screenshots of FXS Port 2 Page



WELCOME

The HT802 analog telephone adapter provides transparent connectivity for analog phones and faxes to the world of internet voice. Connecting to any analog phone, fax or PBX, the HT802 is an effective and flexible solution for accessing internet-based telephone services and corporate intranet systems across established LAN and internet connections. The Grandstream handy tone HT802 is a new addition to the popular handy tone ATA product family. This manual will help you learn how to operate and manage your HT802 analog telephone adaptor and make the best use of its many upgraded features including simple and quick installation, 3- way conferencing, direct IP-IP Calling, and new provisioning support among other features. This HT802 is very easy to manage and configure, and is specifically designed to be an easy to use and affordable VoIP solution for both the residential user and the teleworker.



PRODUCT OVERVIEW

The HT802 is a 2-port analog telephone adapter (ATA) that allows users to create a high-quality and manageable IP telephony solution for residential and office environments. Its ultra-compact size, voice quality, advanced VoIP functionality, security protection and auto provisioning options enable users to take advantage of VoIP on analog phones and enables service providers to offer high quality IP service. The HT802 is an ideal ATA for individual use and for large scale commercial IP voice deployments.

Feature Highlights

The following table contains the major features of the HT802:

Table 1: HT802 Features at a Glance

 <p>HT802</p>	<ul style="list-style-type: none"> • 2 SIP profiles through 2 FXS ports and single 10/100Mbps port • 3-way voice conferencing • Wide range of caller ID formats • Advanced telephony features, including call transfer, call forward, call-waiting, do not disturb, message waiting indication, multi-language prompts, flexible dial plan and more • T.38 Fax for creating Fax-over-IP and GR-909 Line Testing Functionalities • TLS and SRTP security encryption technology to protect calls and accounts • Automated provisioning options include TR-069 and XML config files • Failover SIP server automatically switches to secondary server if main server loses connection
--	---

HT802 Technical Specifications

Following tables resumes all the technical specifications including the protocols/standards supported, voice codecs, telephony features, languages and upgrade/provisioning settings for the HT802.

Table 2: HT802 Technical Specifications

Interfaces	
Telephone Interfaces	Two (2) RJ11 FXS ports.
Network Interface	One (1) 10/100Mbps auto-sensing Ethernet port (RJ45).
LED Indicators	POWER, INTERNET, PHONE1, PHONE2.
Factory Reset Button	Yes.
Voice, Fax, Modem	
Telephony Features	Caller ID display or block, call waiting, flash, blind or attended transfer, forward, hold, do not disturb, 3-way conference.



Voice Codecs	G.711 with Annex I (PLC) and Annex II (VAD/CNG), G.723.1, G.729A/B, G.726, iLBC, OPUS, dynamic jitter buffer, advanced line echo cancellation.
Fax over IP	T.38 compliant Group 3 Fax Relay up to 14.4kpbs and auto-switch to G.711 for Fax Pass-through.
Short/Long Haul Ring Load	2 REN: Up to 1km on 24 AWG.
Caller ID	Bellcore Type 1 & 2, ETSI, BT, NTT, and DTMF-based CID.
Disconnect Methods	Busy Tone, Polarity Reversal/Wink, Loop Current.
Signaling	
Network Protocols	TCP/IP/UDP, RTP/RTCP, HTTP/HTTPS, ARP/RARP, ICMP, DNS, DHCP, NTP, TFTP, TELNET, STUN, SIP (RFC3261), SIP over TCP/TLS, SRTP, TR-069.
QoS	Layer 3 (ToS, DiffServ, MPLS).
DTMF Methods	In-audio, RFC2833 and/or SIP INFO.
Provisioning and Control	HTTP, HTTPS, TELNET, TFTP, TR-069, secure and automated provisioning using AES encryption, syslog.
Security	
Media	SRTP.
Control	TLS/SIPS/HTTPS.
Management	Syslog support, telnet, remote management using web browser.
Physical	
Universal Power Supply	Input: 100-240VAC, 50-60Hz. Output: 5.0VDC/1.0A.
Environmental	Operational: 32° – 104°F or 0° – 40°C. Storage: 14° – 140°F or -10° – 60°C. Humidity: 10 – 90% Non-condensing.
Dimensions and Weight	100mm x 100mm x 29.5mm, 114g (without package).
Compliance	
Compliance	FCC 15B, AS/NZS CISPR22, AS/NZS60950, EN55022, EN55024, EN60950, EN61000-3-2, EN61000-3-3, UL (Power supply).



GETTING STARTED

This chapter provides basic installation instructions including the list of the packaging contents and also information for obtaining the best performance with the HT802.

Equipment Packaging

The HT802 ATA package contains:

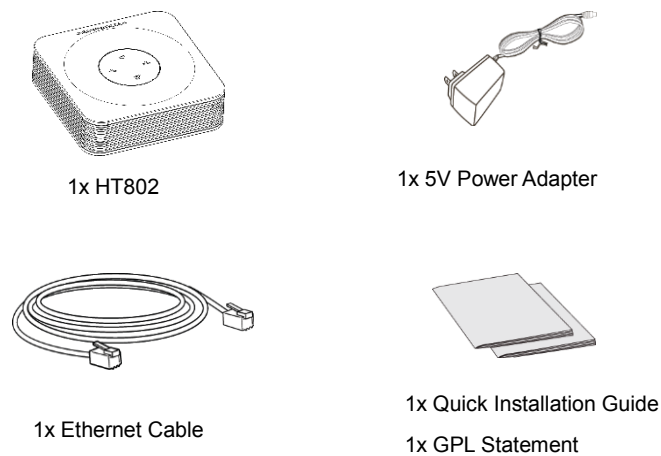

Figure 1: HT802 Package Contents

Note: Check the package before installation. If you find anything missing, contact your system administrator.

HT802 Ports Description

The following figure describes the different ports on the back panel of the HT802.

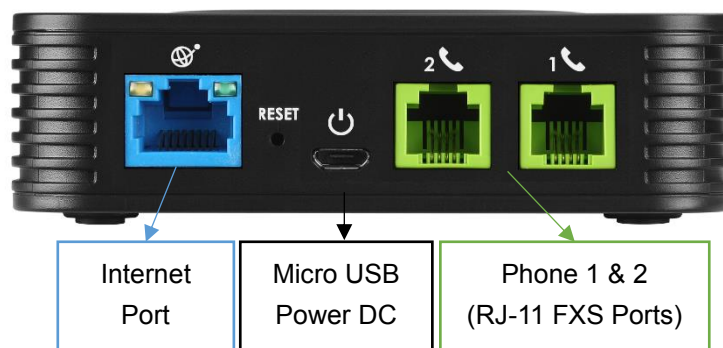

Figure 2: HT802 Back Panel



Table 3: Definition of the HT802 Connectors

Phone 1 & 2	Connects the analog phones / fax machines to the phone adapter using an RJ-11 telephone cable.
Internet port	Connects the phone adapter to your router or gateway using an Ethernet RJ45 network cable.
Micro-USB Power	Connects the phone adapter to PSU (5V – 1A).
Reset	Factory reset button. Press for 7 seconds to reset factory default settings.

Connecting HT802

The HT802 is designed for easy configuration and easy installation, to connect your HT802, please follow the steps above:

1. Insert a standard RJ11 telephone cable into the phone port and connect the other end of the telephone cable to a standard touch-tone analog telephone.
2. Insert the Ethernet cable into the internet or LAN port of the HT802 and connect the other end of the Ethernet cable to an uplink port (a router or a modem, etc.)
3. Insert the power adapter into the HT802 and connect it to a wall outlet.
4. Power, Ethernet and Phone LEDs will be solidly lit when the HT802 is ready for use.

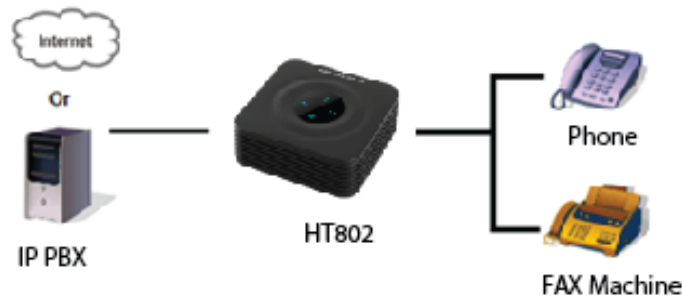

Figure 3: Connecting the HT802

HT802 LEDs Pattern



There are four (4) LED buttons that help you manage the status of your Handy Tone 802.





Figure 4: HT802 LEDs Pattern

Table 4: HT802 LEDs Pattern Description

LED Lights	Status
Power LED 	The Power LED lights up when the HT802 is powered on and it flashes when the HT802 is booting up
Internet LED 	The Ethernet LED lights up when the HT802 is connected to your network through the Ethernet port and it flashes when there is data being sent or received.
Phone LED 1&2 	The phone LED 1 & 2 indicate status of the respective FXS port-phone on the back panel <ul style="list-style-type: none"> • OFF - Unregistered • ON (Solid Blue) - Registered and Available • Blinking every second - Off-Hook / Busy • Slow blinking - FXS LEDs indicates voicemail



CONFIGURATION GUIDE

The HT802 can be configured via one of two ways:

- The IVR voice prompt menu.
- The Web GUI embedded on the HT802 using PC's web browser.

Obtain HT802 IP Address via Connected Analogue Phone

HT802 is by default configured to obtain the IP address from DHCP server where the unit is located. In order to know which IP address is assigned to your HT802, you should access to the "[Interactive Voice Response Menu](#)" of your adapter via the connected phone and check its IP address mode.

Please refer to the steps below to access the interactive voice response menu:

1. Use a telephone connected to phone 1 or phone 2 ports of your HT802.
2. Press *** (press the star key three times) to access the IVR menu and wait until you hear "Enter the menu option".
3. Press 02 and the current IP address will be announced.

Understanding HT802 Interactive Voice Prompt Response Menu

The HT802 has a built-in voice prompt menu for simple device configuration which lists actions, commands, menu choices, and descriptions. The IVR menu works with any phone connected to the HT802. Pick up the handset and dial "****" to use the IVR menu.

Table 5: Voice Prompt Menu

Menu	Voice Prompt	Options
Main Menu	"Enter a Menu Option"	Press "*" for the next menu option Press "#" to return to the main menu Enter 01-05, 07,10, 13-17,47 or 99 menu options
01	"DHCP Mode", "Static IP Mode"	Press "9" to toggle the selection If using "Static IP Mode", configure the IP address information using menus 02 to 05. If using "Dynamic IP Mode", all IP address information comes from the DHCP server automatically after reboot.
02	"IP Address " + IP address	The current WAN IP address is announced If using "Static IP Mode", enter 12 digit new IP address. You need to reboot the HT802 for the new IP address to take Effect.



03	“Subnet “ + IP address	Same as menu 02
04	“Gateway “ + IP address	Same as menu 02
05	“DNS Server “ + IP address	Same as menu 02
07	Preferred Vocoder	Press “9” to move to the next selection in the list: <ul style="list-style-type: none"> • PCM U / PCM A • iLBC • G-726 • G-723 • G-729 • OPUS
10	“MAC Address”	Announces the Mac address of the unit.
13	Firmware Server IP Address	Announces current Firmware Server IP address. Enter 12 digit new IP address.
14	Configuration Server IP Address	Announces current Config Server Path IP address. Enter 12 digit new IP address.
15	Upgrade Protocol	Upgrade protocol for firmware and configuration update. Press “9” to toggle between TFTP / HTTP / HTTPS
16	Firmware Version	Announces Firmware version information.
17	Firmware Upgrade	Firmware upgrade mode. Press “9” to toggle among the following three options: <ul style="list-style-type: none"> • always check • check when pre/suffix changes • never upgrade
47	“Direct IP Calling”	Enter the target IP address to make a direct IP call, after dial tone. (See “ <i>Make a Direct IP Call</i> ”.)
86	Voice Mail	Access to your voice mails messages.
99	“RESET”	Press “9” to reboot the device Enter MAC address to restore factory default setting (See Restore Factory Default Setting section)
	“Invalid Entry”	Automatically returns to main menu
	“Device not registered”	This prompt will be played immediately after off hook If the device is not registered and the option “Outgoing Call without Registration” is in NO

Five success tips when using the voice prompt



- “*” shifts down to the next menu option and “#” returns to the main menu.
- “9” functions as the ENTER key in many cases to confirm or toggle an option.
- All entered digit sequences have known lengths - 2 digits for menu option and 12 digits for IP address. For IP address, add 0 before the digits if the digits are less than 3 (i.e. - 192.168.0.26 should be key in like 192168000026. No decimal is needed).
- Key entry cannot be deleted but the phone may prompt error once it is detected.

Configuration via Web Browser

The HT802 embedded Web server responds to HTTP GET/POST requests. Embedded HTML pages allow a user to configure the HT802 through a web browser such as Google Chrome, Mozilla Firefox and Microsoft’s IE.

Accessing the Web UI

1. Connect the computer to the same network as your HT802.
2. Make sure the HT802 is booted up.
3. You may check your HT802 IP address using the IVR on the connected phone.

Please see [Obtain HT802 IP Address via Connected Analogue Phone](#)

4. Open Web browser on your computer.
5. Enter the HT802’s IP address in the address bar of the browser.
6. Enter the administrator’s password to access the Web Configuration Menu (default password is: admin).

Note: The computer must be connected to the same sub-network as the HT802. This can be easily done by connecting the computer to the same hub or switch as the HT802.

Web UI Access Level Management

There are two default passwords for the login page:

User Level	Password	Web Pages Allowed
End User Level	123	Only Status and Basic Settings
Administrator Level	admin	All pages

The password is case sensitive with maximum length of 25 characters. When changing any settings, always submit them by pressing **Update** or **Apply** button on the bottom of the page. After submitting the changes in all the Web GUI pages, reboot HT802 to have the changes take effect if necessary; most of the options under the **Advanced Settings** and **FXS Port (x)** pages require reboot.

Saving the Configuration Changes

After users makes changes to the configuration, pressing **Update** button will save but not apply the changes



until **Apply** button is clicked. Users can instead directly press **Apply** button. We recommend rebooting or powering cycle the phone after applying all the changes.

Changing Admin Level Password

1. Access your HT802 web UI by entering its IP address in your favorite browser.
2. Enter your admin password (default: admin).
3. Press **Login** to access your settings and navigate to **Advanced Settings > Admin Password**.
4. Enter the new admin password.
5. Confirm the new admin password.
6. Press **Apply** at the bottom of the page to save your new settings.

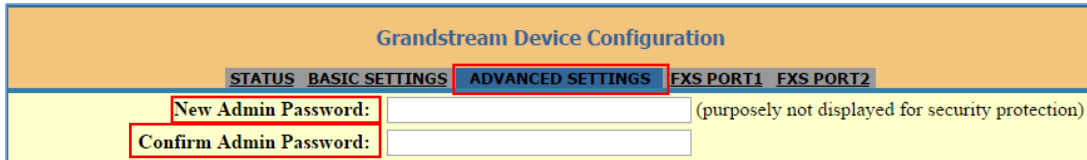

Grandstream Device Configuration

STATUS BASIC SETTINGS ADVANCED SETTINGS FXS PORT1 FXS PORT2

New Admin Password: (purposely not displayed for security protection)

Confirm Admin Password:

Figure 5: Admin Level Password

Changing User Level Password

1. Access your HT802 web UI by entering its IP address in your favorite browser.
2. Enter your admin password (default: admin).
3. Press **Login** to access your settings and navigate to **Basic Settings > End User Password**.
4. Enter the new end-user password.
5. Confirm the new end-user password.
6. Press **Apply** at the bottom of the page to save your new settings.

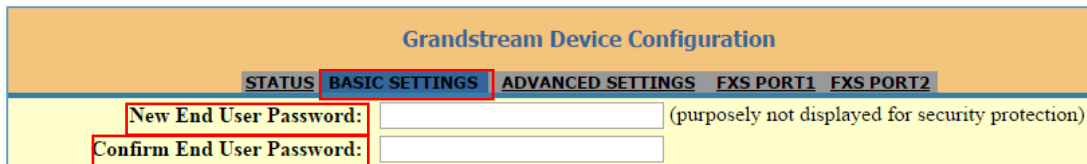

Grandstream Device Configuration

STATUS BASIC SETTINGS ADVANCED SETTINGS FXS PORT1 FXS PORT2

New End User Password: (purposely not displayed for security protection)

Confirm End User Password:

Figure 6: User Level Password

Changing HTTP Web Port

1. Access your HT802 web UI by entering its IP address in your favorite browser.
2. Enter your admin password (default: admin).
3. Press **Login** to access your settings and navigate to **Basic Settings > Web Port**.
4. Change the current port to your desired/new HTTP port. Ports accepted are in range [1-65535].



5. Press **Apply** at the bottom of the page to save your new settings.

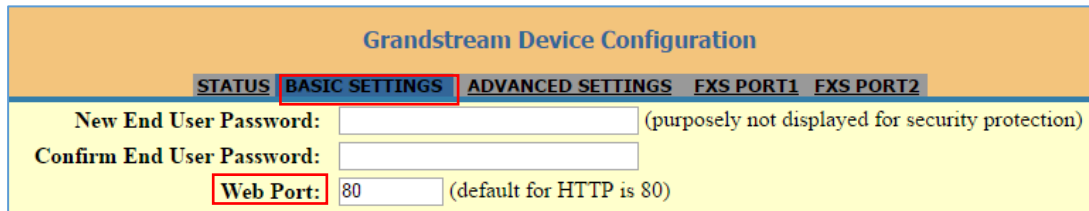

Grandstream Device Configuration

STATUS **BASIC SETTINGS** ADVANCED SETTINGS FXS PORT1 FXS PORT2

New End User Password: (purposely not displayed for security protection)

Confirm End User Password:

Web Port: (default for HTTP is 80)

Figure 7: Web HTTP Port

Web Configuration Pages Definitions

This section describes the options in the HT802 Web UI. As mentioned, you can log in as an administrator or an end user.

- **Status:** Displays the system info, network status, account status, and line options.
- **Basic Settings:** Configures the end user level password, IP address modes, web access, time zone settings and language.
- **Advanced Settings:** Configures networks, upgrading and provisioning, TR-069, security settings, date and time, syslog, audio settings, call settings and call progress tones.
- **FXS Port (1,2):** Configures SIP settings, SIP registration, accounts settings, NAT settings, call features, ring tones.

Status Page Definitions

Table 6: Status Page Definitions

Account Status	
MAC Address	Shows device ID in hexadecimal format. This is needed by network administrators for troubleshooting. The MAC address will be used for provisioning and can be found on the label on original box and on the label located on the bottom panel of the device.
IP Address	Displays assigned IP address. Example: 192.168.5.110.
Product Model	Displays product model info. Default is HT802 .
Hardware Version	Displays the hardware revision information and the part number.
Software version	<ul style="list-style-type: none"> • Program: Specifies Program version. Current is 1.0.3.2 This is the main firmware release number, which is always used for identifying the software system of the HT802. • Bootloader: Specifies Boot version. Current is 1.0.2.3 • Core: Specifies Core version. Current is 1.0.2.3 • Base: Specifies Base version. Current is 1.0.2.5



	<ul style="list-style-type: none"> • CPE: Specifies CPE version. CPE version is displayed only when HT802 is connected to an ACS using TR-069 protocol.
Software Status	Indicates actual software status.
System Up Time	Indicates actual system time and uptime since last reboot.
PPPoE Link Up	Indicates PPPoE connection status.
NAT	Indicates type of NAT when it's configured.
Port Status	Displays relevant information regarding the FXS ports about their registration, DND and call forward features.
Port Options	Displays relevant information regarding the FXS ports about their DND and call forward features.
Provision	Displays provisioning status.
Core Dump	Provides generated core dump file if unit malfunctions. Clean will be displayed if no issues.
GR909	Click on "Test Page" to be redirected to lines tests page (Hazardous Potential, Foreign Electromotive Forces, Resistive Faults, Receiver Off hook and Ringer Equivalent Number)

Basic Settings Page Definitions

Table 7: Basic Settings Page

Basic Settings	
New End User Password	Configures user level password. Case sensitive and max. length of 25 characters.
Confirm End User Password	Re-enter the end user password to confirm change user password on web GUI to avoid typo or mistakes.
Web Port	Customizes HTTP port used to access the HT802 web UI. Default is 80 .
Telnet Server	Enables / Disables access via telnet. Default is Yes (activated).
IP Address	Specifies IP Address to use on HT802. There are three modes to operate the HT802: <ul style="list-style-type: none"> • DHCP mode: all the field values for the static IP mode are not used (even though they are still saved in the flash memory.) The HT802 acquires its IP address from the first DHCP server it discovers from the LAN it is connected.



	<ul style="list-style-type: none"> • Use PPPoE: set the PPPoE account settings. If selected, HT802 attempt to establish a PPPoE session if any of the PPPoE fields is set. • Static IP mode: configure IP address, subnet Mask, default router IP address, 1st preferred DNS server, 2nd preferred DNS server. These fields are set to zero by default.
DHCP hostname	Specifies the name of the client. The name may or may not be qualified with the local domain name. This field is optional but may be required by ISP.
DHCP vendor class ID	Exchanges vendor class ID by clients and servers to convey particular configuration or other identification information about a client. Default is HT8XX .
PPPoE account ID	Defines the PPPoE username. Necessary if ISP requires you to use a PPPoE (Point to Point Protocol over Ethernet) connection.
PPPoE password	Specifies the PPPoE account password.
PPPoE Service Name	Defines PPPoE service name. If your ISP uses a service name for the PPPoE connection, enter the service name here. This field is optional. Default is blank.
Preferred DNS server	Specifies preferred DNS server to use when DHCP or PPPoE are set.
Time Zone	Selects time zone to define date/time on the device.
Self-Defined Time Zone	Allows users to define their own time zone.
Allow DHCP server to set Time Zone	Obtains time zone setting (offset) from a DHCP server using DHCP Option 2; it will override selected time zone. If set to “No”, the analogue adapter will use selected time zone even if provided by DHCP server. The Default setting is Yes .
Language	Configures the languages of the voice prompt and web interface, except Spanish that it is only in IVR. Available languages: English, Chinese or Spanish IVR.
Reset Type	<p>Gives the administrator the option to restore default configuration on the HT802. There are 3 types of factory reset:</p> <ul style="list-style-type: none"> • ISP Data Reset: All VoIP related configuration (mainly everything located on FXS page). • VOIP Data Reset: All ISP (Internet Service Provider) configuration which may affect the IP address.



- **Full Reset:** Both VoIP and ISP related configuration at the same time.
- Note:** After you choose the reset type, you must click the reset button to take effect.

Advanced Settings Page Definitions

Table 8: Advanced Settings

Advanced Settings	
New Admin Password	Defines the administrator level password to access the Advanced Web Configuration page. This field is case sensitive. Only the administrator can configure the “Advanced Settings” page. Password field is purposely left blank for security reasons after clicking update and saved. Max. length is 25 characters.
Confirm Admin Password	Confirms the new admin password.
Layer 2 QoS	Sets values for 802.1Q/VLAN Tag. Default is 0 . Valid range is 0-4094. SIP 802.1p. Default is 0 . Valid range is 0-7. RTP 802.1p. Default is 0 . Valid range is 0-7.
STUN Server is	Configures IP address or domain name of STUN server. Only non-symmetric NAT routers work with STUN.
Keep-alive interval	Sends periodically a blank UDP packet to SIP server in order to keep the "ping hole" on the NAT router open. Default is 20 seconds.
Use STUN to detect network connectivity	Uses STUN keep-alive to detect WAN side network problems. If keep-alive request does not yield any response for configured number of times (minimum 3), the device will restart the TCP/IP stack. If the STUN server does not respond when the device boots up, the feature is disabled. Default setting is No .
Use DNS to detect network connectivity	Uses DNS to detect WAN side network problems. Default setting is No .
Verify host when using HTTPS	Enables / disables the host verification when using HTTPS.
Upgrade via	Selects firmware upgrade/provisioning method: TFTP, HTTP or HTTPS.
Firmware Server Path	Sets IP address or FQDN of firmware server. The URL of the server that hosts the firmware release. Default is fm.grandstream.com/gs .



Config Server Path	Sets IP address or FQDN of configuration server. The URL of the server that hosts the configuration file to provision HT802. Default is fm.grandstream.com/gs .
XML Config File Password	Decrypts XML configuration file when encrypted. The password used for encrypting the XML configuration file using OpenSSL.
HTTP/HTTPS User Name	Enters user name to authenticate with HTTP/HTTPS server.
HTTP/HTTPS Password	Enters password to authenticate with HTTP/HTTPS server.
Firmware File Prefix	Checks if firmware file is with matching prefix before downloading it. This field enables user to store different versions of firmware files in one directory on the firmware server.
Firmware File Postfix	Checks if firmware file is with matching postfix before downloading it. This field enables user to store different versions of firmware files in one directory on the firmware server.
Config File Prefix	Checks if configuration files are with matching prefix before downloading them. This field enables user to store different configuration files in one directory on the provisioning server.
Config File Postfix	Checks if configuration files are with matching postfix before downloading them. This field enables user to store different configuration files in one directory on the provisioning server.
Allow DHCP Option 66 to Override Server	Obtains configuration and upgrade server's information using options 66 from DHCP server. Note: If DHCP Option 66 is enabled, the HT802 will attempt downloading the firmware file from the server URL provided by DHCP, even though Config Server Path is left blank
3CX Auto Provision	Sends multicast "SUBSCRIBE" message for provisioning at booting stage, used for PnP (Plug-and-Play) configuration. Default is Yes .
Automatic Upgrade	Specifies when the firmware upgrade process will be initiated; there are 4 options: <ul style="list-style-type: none"> • No: The HT802 will only do upgrade once at boot up. Default is No. • Check every X minutes: User needs to specify a period in minutes. • Check every day: User needs to specify "Hour of the day (0-23)". • Check every week: User needs to specify "Hour of the day (0-23)" and "Day of the week (0-6)". (Day of week is starting from Sunday).
Always Check for New Firmware at Boot up	Configures the HT802 to always search for the new firmware at boot up. During the boot stage, the HT802 will contact the firmware upgrade server to search for a new firmware, when available it will start the upgrade process, otherwise it will boot normally.



Check New Firmware only when F/W pre/suffix changes	Configure the HT802 to search for the new firmware when the firmware prefix / suffix changes. When this option is selected, the HT802 will check for updates only when the pre/suffix has been changed.
Always Skip the Firmware Check	Configures the HT802 to skip the firmware check, when this option is selected the HT802 will always skip searching for a new firmware.
Disable SIP NOTIFY Authentication	Disables the SIP NOTIFY Authentication on the phone adapter. If set to “Yes”, the phone adapter will not challenge NOTIFY with 401. The default setting is “No”
Authenticate Conf File	Authenticates configuration before being accepted. This protects the configuration from unauthorized modifications. Default is No .
SIP TLS Certificate	Specifies SSL certificate used for SIP over TLS is in X.509 format. The HT802 has built-in private key and SSL certificate.
SIP TLS Private Key	Specifies TLS private key used for SIP over TLS is in X.509 format.
SIP TLS Private Key Password	Specifies SSL Private key password used for SIP Transport in TLS/TCP.
Enable TR-069	Sets the phone adapter system to enable the “CPE WAN Management Protocol” (TR-069). Default setting is No .
ACS URL	Specifies URL of TR-069 Auto Configuration Servers (e.g., http://acs.mycompany.com), or IP address.
ACS Username	Enters username to authenticate to ACS.
ACS Password	Enters password to authenticate to ACS.
Periodic Inform Enable	Sends periodic inform packets to ACS. Default is No
Periodic Inform Interval	Sets frequency that the inform packets will be sent out to ACS.
Connection Request Username	Enters username for ACS to connect to the HT802.
Connection Request Password	Enters password for ACS to connect to the HT802.



CPE SSL Certificate	Configures the Cert File for the phone adapter to connect to the ACS via SSL.
CPE SSL Private Key	Specifies the Cert Key for the phone adapter to connect to the ACS via SSL.
System Ring Cadence	Sets ring cadences for all incoming calls. Syntax: c=on1/off1-on2/off2-on3/off3;) Default is set to c=2000/4000; (US standards), on1 is the period of ringing ("On time" in "ms") while off1 is the period of silence. Up to three cadences are supported.
Call Progress Tones	Configures tone frequencies according to user preference. By default, the tones are set to North American frequencies. Frequencies should be configured with known values to avoid uncomfortable high pitch sounds. ON is the period of ringing (ON time in ms) while OFF is the period of silence. In order to set a continuous ring, OFF should be zero. Otherwise it will ring ON ms and a pause of OFF ms and then repeats the pattern. <ul style="list-style-type: none"> • "Dial tone" • "Ring back tone" • "Busy tone" • "Reorder tone" • "Confirmation tone" • "Call-Waiting tone" • "Prompt Tone" <p>Please refer to the document below to determine your local call progress tones: http://www.itu.int/ITU-T/inr/forms/files/tones-0203.pdf</p>
Prompt Tone Access Code	Specifies the key pattern to get Prompt Tone. Maximum 20 digits
Lock Keypad Update	Locks configuration update via keypad. Default is No .
Disable Voice Prompt	Removes ability to use integrated voice prompt menu configuration. Default is No .
Disable Direct IP Call	Deactivates Direct IP-to-IP calling function. Default is No .
NTP Server	Defines URL or IP address of the NTP (Network Time Protocol). Used by the HT802 to synchronize the date and time. Public NTP servers can be found at http://www.ntp.org . The default value is "pool.ntp.org".



Allow DHCP Option 42 to NTP Server	Obtains NTP server address from a DHCP server using DHCP Option 42; it will override configured NTP Server. If set to “No”, the HT802 will use configured NTP server to synchronize time and date even if a NTP server is provided by DHCP server. Default is Yes .
Syslog Server	Sets IP address or URL of system log server. The server collects system log information from the HT802.
Syslog Level	<p>Selects log level; the level is one of DEBUG, INFO, WARNING, ERROR. Syslog messages are sent based on the following events. Default is NONE:</p> <ol style="list-style-type: none"> 1. product model/version on boot up (INFO level) 2. NAT related info (INFO level) 3. sent or received SIP message (DEBUG level) 4. SIP message summary (INFO level) 5. inbound and outbound calls (INFO level) 6. registration status change (INFO level) 7. negotiated codec (INFO level) 8. Ethernet link up (INFO level) 9. SLIC chip exception (WARNING and ERROR levels) 10. memory exception (ERROR level) <p>The Syslog uses USER facility. In addition to standard Syslog payload, it contains the following components: GS_LOG: [device MAC address] [error code] error message. Example: May 19 02:40:38 192.168.1.14 GS_LOG: [00:0b:82:00:a1:be][000] Ethernet link is up</p>
Send SIP Log	Configures the HT802 to send a replicate of the SIP packets on the syslog. Default is No
Download Device Configuration	Downloads actual device configuration file in .xml format.
Download Device XML Configuration	Downloads actual device configuration file in .xml format.
Upload Firmware	Allows the user to upgrade the firmware with a single firmware file by browsing and loading the file from your computer (local directory).
Upload Configuration	Allows users to upload the configuration file by browsing and loading it from computer (local directory).



FXS Port (1,2) Pages Definitions

Table 9: FXS Port (1,2)

FXS Port (1,2)	
Accounts Active	Activates / Deactivates the accounts. The FXS port configuration will not change if disabled, although the port will not be operational, in this state, there will be no dial tone when picking up the analog phone, and making/receiving calls will not be possible.
Primary SIP Server	Configures SIP server IP address or domain name provided by VoIP service provider. This is the primary SIP server used to send/receive SIP messages from/to HT802.
Failover SIP Server	Specifies failover SIP server IP address or domain name provided by VoIP service provider. This server will be used if the primary SIP server becomes unavailable.
Prefer Primary SIP Server	Selects to prefer primary SIP server. The account will register to primary Server if registration with Failover server expires. Default is No .
Outbound Proxy	Specifies IP address or domain name of outbound Proxy, or media gateway, or session border controller. Used by HT802 for firewall or NAT penetration in different network environments. If symmetric NAT is detected, STUN will not work and only outbound proxy can correct the problem.
Allow DHCP Option 120 (override SIP Server)	Configures the HT802 to collect SIP server address from DHCP option 120. Default is No
SIP transport	Selects transport protocol for SIP packets; UDP or TCP or TLS. Please make sure your SIP Server or network environment supports SIP over the selected transport method. Default is UDP .
NAT Traversal	Indicates type of NAT for each account. This parameter configures whether the NAT traversal mechanism is activated. Users could select the mechanism from No, Keep-alive, STUN, UPnP. Default setting is No .
SIP User ID	Defines user account information provided by VoIP service provider (ITSP). Usually in the form of digit similar to phone number or actually a phone number.
Authenticate ID	Determines account authenticate ID provided by VoIP service provider (ITSP). Can be identical to or different from "SIP user ID".
Authenticate Password	Specifies account password provided by VoIP service provider (ITSP) to register to SIP servers.



Name	Chooses a name to be associated to user.
DNS Mode	<p>Selects DNS mode to use for the client to look up server. One mode can be chosen.</p> <ul style="list-style-type: none"> • A Record: resolves IP Address of target according to domain name. • SRV: DNS SRV resource records indicate how to find services for various protocols. • NAPTR/SRV: Naming Authority Pointer according to RFC 2915. • Use Configured IP: If selected, please fill in Primary IP, Backup IP 1 and Backup IP 2 to be used for server look up. Default is A Record.
DNS SRV use Registered IP	When this option is set to “Yes”, when the HT is registered on second SRV and makes an outbound call, it will try the second SRV (registered IP) first. By default, this option is disabled and the DNS SRV will use first SRV instead of the registered IP.
TEL URI	<p>Indicates E.164 number in “From” header by adding “User=Phone” parameter or using “Tel:” in SIP packets, if the HT802 has an assigned PSTN Number.</p> <ul style="list-style-type: none"> • Disabled: Use “SIP User ID” information in the Request-Line and “From” header. • User=Phone: “User=Phone” parameter will be attached to the Request-Line and “From” header in the SIP request to indicate the E.164 number. If set to “Enable”. • Enabled: “Tel:” will be used instead of “sip:” in the SIP request. <p>Please consult your carrier before changing this parameter. Default is Disabled.</p>
SIP Registration	Controls whether the HT802 needs to send REGISTER messages to the proxy server. Default setting is Yes .
Unregister on Reboot	Controls whether to clear SIP user’s information by sending un-register request to the proxy server. The un-registration is performed by sending a REGISTER message with Contact set to * and Expires=0 parameters to the SIP server. This will unregister the SIP account under the concerned FXS page. Default is No .
Outgoing Call Without Registration	Enables the ability to place outgoing calls even if the account is not registered (if allowed by ITSP); device will not be able to receive incoming calls. Default is No .
Register Expiration	Refreshes registration periodically with specified SIP proxy (in minutes). Maximum interval is 65535 minutes (about 45 days). Default is 60 minutes (or 1 hour).



Reregister Before Expiration	Sends re-register request after specific time (in seconds) to renew registration before the previous registration expires.
SIP Registration Failure Retry Wait Time	Sends re-register request after specific time (in seconds) when registration process fails. Maximum interval is 3600 seconds (1 hour). Default is 20 seconds.
SIP Registration Failure Retry Wait Time upon 403 Forbidden	Sends re-register request after specific time (in seconds) when registration process fails with error 403 Forbidden. Maximum interval is 3600 seconds (1 hour). Default is 1220 seconds.
Enable SIP OPTIONS Keep Alive	Enables SIP OPTIONS to track account registration status so the phone adapter will send periodic OPTIONS message to server to track the connection status with the server. Default setting is "No"
SIP OPTIONS Keep Alive Interval	Configures the time interval when the phone adapter send OPTIONS message to SIP server. The default setting is 30 seconds, which means the phone adapter will send an OPTIONS message to the server every 30 seconds. The default range is 1-64800
SIP OPTIONS Keep Alive Max Lost	Defines the Number of max lost packets for SIP OPTIONS Keep Alive before re-registration. Between 3-10, default is 3 .
Layer 3 QoS	Defines Diff-Serv values for SIP and RTP. Defaults are: SIP Diff-Serv: 26 RTP Diff-Serv: 46
Local SIP Port	Defines local port to use by the HT802 for listening and transmitting SIP packets. Default value for FXS 1 is 5060 and 5062 for FXS 2.
Local RTP Port	Defines the local RTP-RTCP port pair the HT802 will listen and transmit. It is the HT802 RTP port for channel 0. The default value for FXS port is 5004 .
Use Random SIP Port	Controls whether to use configured or random SIP ports. This is usually necessary when multiple HT802 are behind the same NAT. Default is No .
Use Random RTP Port	Controls whether to use configured or random RTP ports. This is usually necessary when multiple HT802 are behind the same NAT. Default is No .
Hold Target Before Refer	Allows user to hold the phone call before refer it. If set to No, the call will not be hold before referred. Default is Yes .
Refer-To Use Target Contact	Includes target's "Contact" header information in "Refer-To" header when using attended transfer. Default is No .



Transfer on Conference Hang-up	If set to "Yes", when the phone hangs up as the conference initiator, the conference call will be transferred to the other parties so that other parties will remain in the conference call. Default setting is No .
Disable Bellcore Style 3-Way Conference	Gives the users the possibility of making conference calls by pressing "Flash" key, when it's enabled by dialing *23 +second callee number. Default is No
Remove OBP from Route Header	Removes outbound proxy info in "Route" header when sending SIP packets. Default is No .
Support SIP Instance ID	Includes "SIP Instance ID" attribute to "Contact" header in REGISTER request as defined in IETF SIP outbound draft. Default is No .
Validate Incoming Messages	Validates incoming messages. Default is No .
Check SIP User ID for Incoming INVITE	Checks SIP User ID in the Request URI of incoming INVITE; if it doesn't match the HT802 SIP User ID, the call will be rejected. Direct IP calling will also be disabled. Default is No .
Authenticate Incoming INVITE	Challenges the incoming INVITE for authentication with SIP 401 Unauthorized message. Default is No .
Authenticate server certificate domain	Configures whether to validate the domain certificate when download the firmware/config file. If it is set to "Yes", the phone will download the firmware/config file only from the legitimate server. The default setting is " No ".
Authenticate server certificate chain	Configures whether to validate the server certificate when download the firmware/config file. If it is set to "Yes", the phone will download the firmware/config file only from the legitimate server. The default setting is " No ".
Trusted CA Certificates	Uses the certificate for Authentication if "Check Domain Certificates" is set to "Yes" under "Account" -> "SIP Settings".
Allow Incoming SIP Messages from SIP Proxy Only	Checks SIP address of the Request URI in the incoming SIP message; if it doesn't match the SIP server address of the account, the call will be rejected. Default is No .
Use Privacy Header	Determines if the "Privacy header" will be presented in the SIP INVITE message and if it includes the caller info in this header. If set to Default, it will add Privacy header unless special feature is Telkom SA or CBCOM . Default is Default .



Use P-Preferred-Identity Header	Specifies if the P-Preferred-Identity Header will be presented in the SIP INVITE message. If set to "default", the P-Preferred-Identity Header will be omitted in SIP INVITE message when Telkom SA or CBCO is active. If set to "Yes", the P-Preferred-Identity Header will always be presented. If set to "No", it will be omitted. Default setting is: Default .
SIP REGISTER Contact Header Uses	Specifies which address (LAN or WAN address) the device will detect to use it in SIP Register Contact Header. When set to LAN , Contact header will include local IP from ATA in REGISTER messages, while if set to WAN , host/port/contact will be updated from SIP 401/403/404/407 Via header "received"/"rport" parameters in REGISTER messages. Default is LAN Address .
SIP T1 Timeout	Defines T1 timeout value. It is an estimate of the round-trip time between the client and server transactions. For example, the HT802 will attempt to send a request to a SIP server. The time it takes between sending out the request to the point of getting a response is the SIP T1 timer. If no response is received the timeout is increased to (2*T1) and then (4*T1). Request re-transmit retries would continue until a maximum amount of time defined by T2. Default is 0.5 seconds.
SIP T2 Interval	Identifies maximum retransmission interval for non-INVITE requests and INVITE responses. Retransmitting and doubling of T1 continues until it reaches T2 value. Default is 4 seconds.
SIP Timer D	Configure the SIP Timer D defined in RFC3261. 0 - 64 seconds. Default 0
DTMF Payload Type	Defines payload type for DTMF using RFC2833.
Preferred DTMF method (in order)	Sorts DTMF methods (in-audio, via RTP (RFC2833) or via SIP INFO) by priority.
Disable DTMF Negotiation	Uses above DTMF order without negotiation. Default is No .
Generate Continuous RFC2833 Events	When enabled the RFC2833 events are generated until key is released. Default is No.
Send Hook Flash Event	Default is No . If set to yes, flash will be sent as DTMF event.



Flash Digit Control	Overrides the default settings for call control when both channels are in use
Enable Call Features	Enables do not disturb, call forward and other call features via the local feature codes on the base. Otherwise, ITSP feature codes can be used. Default is Yes .
Off Hook Auto Dial	Configures a user ID or extension number that is automatically dialed when off-hook. Only the user part of a SIP address needs to be entered. The HT802 will automatically append the "@" and the host portion of the corresponding SIP address.
Off Hook Auto Dial Delay	Specifies the auto-dial delay after off hook.
Proxy-Require	Determines a SIP Extension to notify the SIP server that the HT802 is behind a NAT/Firewall.
Use NAT IP	Defines NAT IP address used in SIP/SDP messages. It should only be used if required by ITSP.
Use SIP User Agent Header	Configures the SIP User-Agent Header.
Distinctive Ring Tone	<p>Customizes the Ring Tone 1 to 3 with associate caller ID: when selected, if caller ID is configured, then the device will ONLY use this ring tone when the incoming call is from the Caller ID. System Ring Tone is used for all other calls. When selected but no Caller ID is configured, the selected ring tone will be used for all incoming calls using the FXS port. Distinctive ring tones can be configured not only for matching a whole number, but also for matching prefixes. In this case symbol * (star) will be used.</p> <p>For example: If configured as *617, Ring Tone 1 will be used in case of call arrived from the area code 617. Any other incoming call will ring using cadence defined in parameter System Ring Cadence located under Advanced Settings Configuration page.</p> <p>Note: If server supports Alert-Info header and standard ring tone set (Bellcore) or distinctive ring tone 1-10 is specified, then the ring tone in the Alert-Info header from server will be used. Bellcore rings and tones are independent from custom ring tones. The custom ring tones can also be specified by alert-info header, for example Alert-Info: ;info=ring5</p>
Disable Call Waiting	Disables receiving a second incoming call when the line is engaged. Default is No .
Disable Call Waiting Caller ID	Disables displaying caller ID when receiving a second incoming call. Default is No .



Disable Call Waiting Tone	Disables playing call waiting tone during active call when receiving a second incoming call. The CWCID will still be displayed. Default is No .
Disable Connected Line ID	Disables displaying the number of the person answering the phone. Default is No .
Disable Receiver Off hook Tone	Enables / disables the warning to alert that the phone has been left off-hook for an extended period of time. Default is No .
Disable Reminder Ring for On-Hold Call	Enables playing the reminder ring. Default is No
Disable Visual MWI	Disables use of visual message waiting indicator when there is an unread voicemail message. Default is No .
Do Not Escape '#' as %23 in SIP URI	Replaces # by %23 in some special situations. Default is No .
Disable Multiple m Line in SDP	Sends only one m line in SDP, regardless of how many m fields are in the incoming SDP. Default is No .
Ring Timeout	Stops ringing when incoming call if not answered within a specific period of time. Default is 60 seconds.
Delayed Call Forward Wait Timeout	Forwards incoming call if not answered within a specific period of time when delayed call forward is activated locally (using *92 code). Default value is 20 seconds.
No Key Entry Timeout	Initiates the call within this time interval if no additional key entry during dialing stage. Default is 4 seconds.
Early Dial	Sends an early INVITE each time a key is pressed when a user dials a number. Otherwise, only one INVITE is sent after full number is dialed (user presses Dial Key or after “no key entry timeout” expires). This option should be used only if there is a SIP proxy is configured and supporting 484 responses (Incomplete Address). Otherwise, the call will likely be rejected by the proxy (with a 404 Not Found error). Default is No . <i><u>This feature is NOT designed to work with and should NOT be enabled for direct IP-to-IP calling.</u></i>
Dial Plan Prefix	Adds specified prefix to dialed number.
Use # as Dial Key	Treats “#” as the “Send” (or “Dial”) key. If set to “No”, this “#” key can be included as part of the dialed number. Default is Yes .



Dial Plan
Dial Plan Rules:

1. Accept Digits: 1,2,3,4,5,6,7,8,9,0 , * , #, A,a,B,b,C,c,D,d
2. Grammar: **x** - any digit from 0-9;
 - a. **xx+** - at least 2 digits number;
 - b. **xx** – exactly 2 digits number;
 - c. **^** - exclude;
 - d. **.** – wildcard, matches one or more characters
 - e. **[3-5]** - any digit of 3, 4, or 5;
 - f. **[147]** - any digit 1, 4, or 7;
 - g. **<2=011>** - replace digit 2 with 011 when dialing
 - h. **<=1>** - add a leading 1 to all numbers dialed, vice versa will remove a 1 from the number dialed
 - i. **|** - or
 - **Example 1:** {[369]11 | 1617xxxxxxx} –
Allow 311, 611, 911, and any 10 digit numbers of leading digits 1617
 - **Example 2:** {^1900x+ | <=1617>xxxxxxx} –
Block any number with leading digits 1900 and add prefix 1617 for any dialed 7 digit numbers
 - **Example 3:** {1xxx[2-9]xxxxxx | <2=011>x+} –
Allow any length of number with leading digit 2 and 10 digit-numbers of leading digit 1 and leading exchange number between 2 and 9; If leading digit is 2, replace leading digit 2 with 011 before dialing.
3. Default: Outgoing - {x+}

Example of a simple dial plan used in a Home/Office in the US:

{ ^1900x. | <=1617>[2-9]xxxxxx | 1[2-9]xx[2-9]xxxxxx | 011[2-9]x. | [3469]11 }

Explanation of example rule (reading from left to right):

- **^1900x.** - prevents dialing any number started with 1900
- **<=1617>[2-9]xxxxxx** - allows dialing to local area code (617) numbers by dialing 7 numbers and 1617 area code will be added automatically
- **1[2-9]xx[2-9]xxxxxx** - allows dialing to any US/Canada Number with 11 digits length
- **011[2-9]x.** - allows international calls starting with 011
- **[3469]11** - allow dialing special and emergency numbers 311, 411, 611 and 911

Note: In some cases, user wishes to dial strings such as *123 to activate voice mail or other application provided by service provider. In this case * should be predefined inside dial plan feature. An example dial plan will be: **{ *x+ }** which allows the user to dial *



	followed by any length of numbers.
SUBSCRIBE for MWI	Sends SUBSCRIBE periodically (depends on “Register Expiration” parameter) for message waiting indication. Default is No .
Send Anonymous	Sets “From”, “Privacy” and “P_Asserted_Identity” headers in outgoing INVITE message to “anonymous”, blocking caller ID. Default is No .
Anonymous Call Rejection	Rejects incoming calls with anonymous caller ID with “486 Busy here” message. Default is No .
Special Feature	Selects Soft switch vendors’ special requirements Example of vendors: Broadsoft, CBCOM, RNK, Huawei, ZTE IME, Phone Power, Metaswitch. Default is Standard .
Session Expiration	Enables SIP sessions to be periodically “refreshed” via a SIP request (UPDATE, or re-INVITE). When the session interval expires, if there is no refresh via an UPDATE or re-INVITE message, the session will be terminated. Session Expiration is the time (in seconds) at which the session is considered timed out, if no successful session refresh transaction occurs beforehand. Default is 180 seconds.
Min-SE	Defines Minimum session expiration (in seconds). Default is 90 seconds.
Caller Request Timer	Uses session timer when making outbound calls if remote party supports it. Default is No .
Callee Request Timer	Uses session timer when receiving inbound calls with session timer request. Default is No .
Force Timer	Uses session timer even if the remote party does not support this feature. Selecting “No” will enable session timer only when the remote party supports it. Default is No . To turn off Session Timer, select “No” for Caller and Callee Request Timer, and Force Timer.
UAC Specify Refresher	Specifies which end will act as refresher for outgoing calls. Default is Omit.: <ul style="list-style-type: none"> • UAC: The handy tone acts as the refresher. • UAS: Callee or proxy server act as the refresher.
UAS Specify Refresher	Specifies which end will act as refresher for incoming calls. Default is Omit.: <ul style="list-style-type: none"> • UAS: The handy tone acts as the refresher. • UAC: Callee or proxy server act as the refresher.
Force INVITE	Uses INVITE message to refresh the session timer. Default is No .
Enable 100rel	Appends “100rel” attribute to the value of the required header of the initial signaling



	messages. Default is No .
Add Auth Header on Initial REGISTER	Adds "Authentication" header with blank "nonce" attribute in the initial SIP REGISTER request. Default is No .
Use First Matching Vocoder in 200OK SDP	Includes only the first matching vocoder in its 200OK response, otherwise it will include all matching vocoders in same order received in INVITE. Default is No .
Preferred Vocoder	Configures vocoders in a preference list (up to 7 preferred vocoders) that will be included with same order in SDP message. Vocoder types are G.711 A-/U-law, G.722, G.726-32, G.723, G.729, iLBC and OPUS
Voice Frames per TX	Transmits a specific number of voice frames per packet. Default is 2 ; increases to 10/20/32/64 for G711/G726/G723/other codecs respectively.
G723 Rate	Operates at specified encoding rate for G.723 vocoder. Available encoding rates are 6.3kbps or 5.3kbps. Default is 6.3kbps .
iLBC Frame Size	Specifies iLBC packet frame size (20ms or 30ms). Default is 20ms .
Disable OPUS Stereo in SDP	Disables OPUS stereo in SDP. Default is No .
iLBC Payload type	Determines payload type for iLBC. Valid range is between 96 and 127. Default is 97 .
OPUS Payload Type	Determines payload type for OPUS. Valid range is between 96 and 127. Default is 123 .
VAD	Allows detecting the absence of audio and conserves bandwidth by preventing the transmission of "silent packets" over the network. Default is No .
Symmetric RTP	Changes the destination to send RTP packets to the source IP address and port of the inbound RTP packet last received by the device. Default is No .
Fax Mode	Specifies the fax mode : T.38 (Auto Detect) FoIP by default, or Pass-Through (must use codec PCMU/PCMA)
Re-Invite after Fax Tone Detection Mode	Permits the unit to send out the re-INVITE for T.38 or Fax Pass Through if a fax tone is detected. Default is Enabled
Jitter Buffer Type	Selects jitter buffer type (Fixed or Adaptive) based on network conditions.
Jitter Buffer Length	<ul style="list-style-type: none"> High (initial 200ms, min 40ms, max 600ms) Note: not all vocoders can meet the high requirement.



	<ul style="list-style-type: none"> • Medium (initial 100ms, min 20ms, max 200ms). • Low (initial 50ms, min 10ms, max 100ms).
SRTP Mode	<p>Selects SRTP mode to use (“Disabled”, “Enabled but not forced”, or “Enabled and forced”). Default is Disabled.</p> <p>It uses SDP Security Description to exchange key. Please refer to SDES: https://tools.ietf.org/html/rfc4568 SRTP: https://www.ietf.org/rfc/rfc3711.txt</p>
Crypto Life Time	Adds crypto life time header to SRTP packets. Default is Yes .
SLIC Setting	Depends on standard phone type (and location).
Caller ID Scheme	Selects the caller id scheme, for example : Bellcore/Telcordia, ETSI-FSK ...
DTMF Caller ID	Defines the start and stop tones.
Polarity Reversal	Reverses the polarity upon call establishment and termination. Default is No .
Loop Current Disconnect	Allows the traditional PBX used with HT802 to apply this method for signaling call termination. Method initiates short voltage drop on the line when remote (VoIP) side disconnects an active call. Default is No .
Loop Current Disconnect Duration	Configures the duration of voltage drop described in topic above. HT802 supports a duration range from 100 to 10000 ms. Default value is 200 .
Enable Hook Flash	Enables the FLASH button to be used for terminating calls. Default is Yes .
Hook Flash Timing	Defines the time period when the cradle is pressed (Hook Flash) to simulate FLASH. To prevent unwanted activation of the Flash/Hold and automatic phone ring-back, adjust this time value. HT802 supports a range from 40 to 2000 ms. Default values are 300 minimum and 1100 maximum.
On Hook Timing	Specifies the on-hook time for an on-hook event to be validated. HT802 supports a range from 40 to 2000 ms. Default value is 400 .
Gain	<p>Adjusts the voice path volume.</p> <ul style="list-style-type: none"> • Rx is a gain level for signals transmitted by FXS • Tx is a gain level for signals received by FXS. <p>Default = 0dB for both parameters. Loudest volume: +6dB Lowest volume: -6dB.</p> <p>User can adjust volume of call using the Rx gain level parameter and the Tx gain level parameter located on the FXS port configuration page.</p> <p>If call volume is too low when using the FXS port (ie. the ATA is at user site), adjust</p>



	volume using the Rx gain level parameter under the FXS port configuration page. If voice volume is too low at the other end, user may increase the far end volume using the Tx gain level parameter under the FXS port configuration PAGE.
Disable Line Echo Canceller	Disables the LEC will per call base. Recommended for FAX/Data calls. Default is No .
Disable Network Echo Suppressor	Disables the NEC will per call base. Recommended for FAX/Data calls. Default is No .
Outgoing Call Duration Limit	Defines the call duration limit for the outgoing calls, Default is 0 (No limit) .
Ring Frequency	Configures ringing frequency for your phone. 15-60 Hz, Default is 20 Hz.
Ring tones	Configures the ring tone cadence preferences. User has 10 choices. The configuration, completed in Distinctive Ring Tones block in the same page, applies to ring tones cadences configured here.

NAT Settings

If you plan to keep the handy tone within a private network behind a firewall, we recommend using STUN Server. The following three settings are useful in the STUN Server scenario:

1. STUN Server (under advanced settings webpage) enter a STUN server IP (or FQDN) that you may have, or look up a free public STUN server on the internet and enter it on this field. If using public IP, keep this field blank.
2. Use random SIP/RTP ports (under advanced settings webpage), this setting depends on your network settings. Generally, if you have multiple IP devices under the same network, it should be set to Yes. If using a public IP address, set this parameter to No.
3. NAT traversal (under the FXS web page) Set this to Yes when gateway is behind firewall on a private network.

DTMF Methods

The HT802 support the following DTMF mode:

- DTMF in-audio
- DTMF via RTP (RFC2833)
- DTMF via SIP INFO

Set priority of DTMF methods according to your preference. This setting should be based on your server DTMF setting.



Preferred Vocoder (Codec)

The HT802 supports following voice codecs. On FXS ports pages, choose the order of your favorite codecs:

- PCMU/A (or G711 μ /a)
- G729 A/B
- G723.1
- G726 (16/24/32/40)
- iLBC
- OPUS

Configuring HT802 Through Voice Prompts

As mentioned previously, The HT802 has a built-in voice prompt menu for simple device configuration. Please refer to "[Understanding HT802 Interactive Voice Prompt Response Menu](#)" for more information about IVR and how to access its menu.

- **DHCP MODE**
Select voice menu option 01 to enable HT802 to use DHCP.
- **STATIC IP MODE**
Select voice menu option 01 to enable HT802 to use STATIC IP mode, then use option 02, 03, 04, 05 to set up IP address, Subnet Mask, Gateway and DNS server respectively.
- **FIRMWARE SERVER IP ADDRESS**
Select voice menu option 13 to configure the IP address of the firmware server.
- **CONFIGURATION SERVER IP ADDRESS**
Select voice menu option 14 to configure the IP address of the configuration server.
- **UPGRADE PROTOCOL**
Select the menu option 15 to choose firmware and configuration upgrade protocol between TFTP, HTTP and HTTPS.
- **FIRMWARE UPGRADE MODE**
Select voice menu option 17 to choose firmware upgrade mode among the following three options:
1) Always check, 2) check when pre/suffix changes, and 3) never upgrade.

Register a SIP Account

The HT802 supports 2 FXS ports which can be configured with 2 SIP accounts. Please refer to the following steps in order to register your accounts via web user interface :

1. Access your HT802 web UI by entering its IP address in your favorite browser.
2. Enter your admin password (default: admin).
3. Press **Login** to access your settings.
4. Go to **FXS Port (1 or 2)** pages.



5. In **FXS Port** tab, set the following:
 - a. **Account Active** to **Yes**.
 - b. **Primary SIP Server** field with your SIP server IP address or FQDN.
 - c. **Failover SIP Server** with your Failover SIP Server IP address or FQDN. Leave empty if not available.
 - d. **Prefer Primary SIP Server** to **No** or **Yes** depending on your configuration. Set to **No** if no Failover SIP Server is defined. If “**Yes**”, account will register to Primary SIP Server when failover registration expires.
 - e. **Outbound Proxy**: Set your Outbound Proxy IP Address or FQDN. Leave empty if not available.
 - f. **SIP User ID**: User account information, provided by VoIP service provider (ITSP). Usually in the form of digit similar to phone number or actually a phone number.
 - g. **Authenticate ID**: SIP service subscriber’s Authenticate ID used for authentication. Can be identical to or different from SIP User ID.
 - h. **Authenticate Password**: SIP service subscriber’s account password to register to SIP server of ITSP. For security reasons, the password will field will be shown as empty.
 - i. **Name**: Any name to identify this specific user.

For more information, related to above options please refer to [FXS Port Settings](#).

6. Press **Apply** at the bottom of the page to save your configuration.

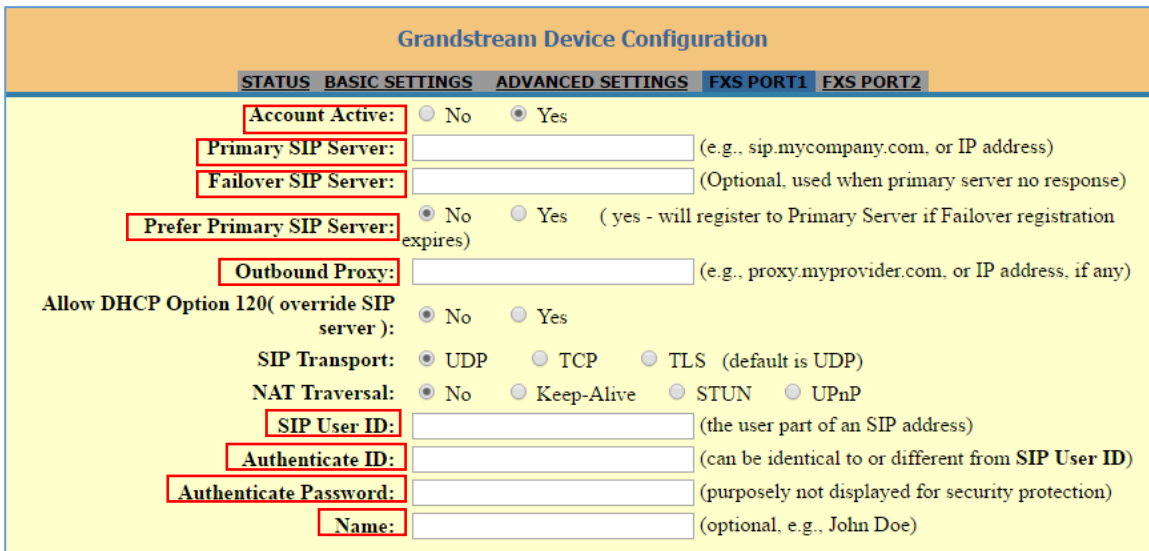

Grandstream Device Configuration

STATUS BASIC SETTINGS ADVANCED SETTINGS **FXS PORT1** FXS PORT2

Account Active: No Yes

Primary SIP Server: (e.g., sip.mycompany.com, or IP address)

Failover SIP Server: (Optional, used when primary server no response)

Prefer Primary SIP Server: No Yes (yes - will register to Primary Server if Failover registration expires)

Outbound Proxy: (e.g., proxy.myprovider.com, or IP address, if any)

Allow DHCP Option 120(override SIP server): No Yes

SIP Transport: UDP TCP TLS (default is UDP)

NAT Traversal: No Keep-Alive STUN UPnP

SIP User ID: (the user part of an SIP address)

Authenticate ID: (can be identical to or different from SIP User ID)

Authenticate Password: (purposely not displayed for security protection)

Name: (optional, e.g., John Doe)

Figure 8: SIP Accounts Settings

After applying your configuration, your account will register to your SIP Server, you can verify if it has been correctly registered with your SIP server from your HT802 web interface under **Status > Port Status > Registration** (If it displays **Registered**, it means that your account is fully registered, otherwise it will display **Not Registered** so in this case you must double check the settings or contact your provider).



Grandstream Device Configuration

STATUS
BASIC SETTINGS
ADVANCED SETTINGS
FXS PORT1
FXS PORT2

MAC Address: 00:0B:82:83:62:0A
 IP Address: 192.168.5.127
 Product Model: HT802
 Hardware Version: V1.5A Part Number -- 9610003715A
 Software Version: Program -- 1.0.3.2 Bootloader -- 1.0.3.1 Core -- 1.0.3.1 Base -- 1.0.3.2
 CPE -- 1.0.1.52
 Software Status: Running Mem: 21336
 System Up Time: 04:25:48 up 8 min
 PPPoE Link Up: Disabled
 NAT: Unknown NAT

Port Status:

Port	Hook	User ID	Registration
FXS 1	On Hook	1000	Registered
FXS 2	On Hook		Not Registered

Port Options:

Port	DND	Forward	Busy Forward	Delayed Forward
FXS 1	No			
FXS 2	No			

Provision: Not running. Last status : Downloading file from url.
 Core Dump: Clean
 GR909: [Test Page](#)

All Rights Reserved Grandstream Networks, Inc. 2006-2017

Figure 9: Account Status

Call Features

The HT802 supports all the traditional and advanced telephony features.

Table 10: HT802 Call Features

Key	Call features
*02	Forcing a Codec (per call) *027110 (PCMU), *027111 (PCMA), *02723 (G723), *02729 (G729), *0272616 (G726-r16), *0272624 (G726-r24), *0272632 (G726-r32), *0272640 (G726-r40), *027201 (iLBC), *027202 (OPUS).
*03	Disable LEC (per call) Dial “*03 +” number “. No dial tone is played in the middle.
*16	Enable SRTP.
*17	Disable SRTP.
*30	Block Caller ID (for all subsequent calls).
*31	Send Caller ID (for all subsequent calls).
*47	Direct IP Calling. Dial “*47” + “IP address”. No dial tone is played in the middle.
*50	Disable Call Waiting (for all subsequent calls).
*51	Enable Call Waiting (for all subsequent calls).



*67	Block Caller ID (per call). Dial “*67” +” number”. No dial tone is played in the middle.
*82	Send Caller ID (per call). Dial “*67” +” number”. No dial tone is played in the middle.
*69	Call Return Service: Dial *69 and the phone will dial the last incoming phone number received.
*70	Disable Call Waiting (per call). Dial “*70” +” number”. No dial tone is played in the middle.
*71	Enable Call Waiting (per call). Dial “*71” +” number”. No dial tone is played in the middle.
*72	Unconditional Call Forward: Dial “*72” and then the forwarding number followed by “#”. Wait for dial tone and hang up. (Dial tone indicates successful forward)
*73	Cancel Unconditional Call Forward. To cancel “Unconditional Call Forward”, dial “*73”, wait for dial tone, then hang up.
*74	Enable Paging Call: Dial “*74” and then the destination phone number you want to page.
*78	Enable Do Not Disturb (DND): When enabled all incoming calls are rejected.
*79	Disable Do Not Disturb (DND): When disabled, incoming calls are accepted.
*87	Blind Transfer.
*90	Busy Call Forward: Dial “*90” and then the forwarding number followed by “#”. Wait for dial tone then hang up.
*91	Cancel Busy Call Forward. To cancel “Busy Call Forward”, dial “*91”, wait for dial tone, then hang up.
*92	Delayed Call Forward. Dial “*92” and then the forwarding number followed by “#”. Wait for dial tone then hang up.
*93	Cancel Delayed Call Forward. To cancel Delayed Call Forward, dial “*93”, wait for dial tone, then hang up.
Flash/ Hook	Toggles between active call and incoming call (call waiting tone). If not in conversation, flash/hook will switch to a new channel for a new call.
#	Pressing pound sign will serve as Re-Dial key.

Rebooting HT802 from Remote

Press the “Reboot” button at the bottom of the configuration menu to reboot the ATA remotely. The web browser will then display a message window to confirm that reboot is underway. Wait 30 seconds to log in again.



UPGRADING AND PROVISIONING

The HT802 can be upgraded via TFTP/HTTP/HTTPS by configuring the URL/IP Address for the TFTP/HTTP/HTTPS server and selecting a download method. Configure a valid URL for TFTP or HTTP/HTTPS; the server name can be FQDN or IP address.

Examples of valid URLs:

firmware.grandstream.com

fw.ipvideotalk.com/gs

Firmware Upgrade procedure

Please follow below steps in order to upgrade the firmware version of your HT802:

1. Access your HT802 UI by entering its IP address in your favorite browser.
2. Enter your admin password (default: admin).
3. Press **Login** to access your settings.
4. Go to **Advanced Settings > Firmware Upgrade and Provisioning** page, and enter the IP address or the FQDN for the upgrade server in "**Firmware Server Path**" field and choose to upgrade via **TFTP** or **HTTP/HTTPS**.
5. Make sure to check "**Always Check for New Firmware**".
6. Update the change by clicking the "**Apply**" button at the bottom of the page. Then "**Reboot**" or power cycle the HT802 to update the new firmware.

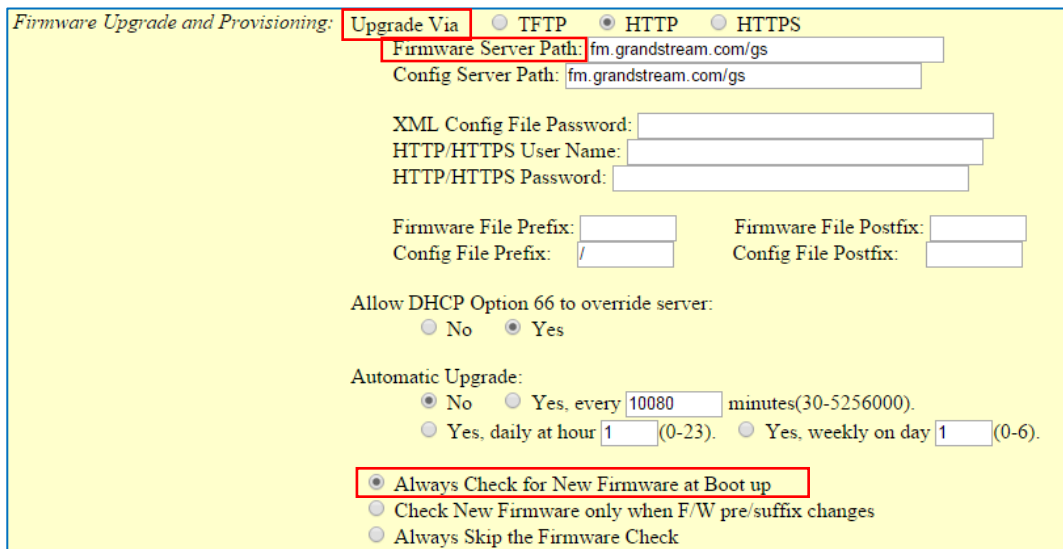

Firmware Upgrade and Provisioning: Upgrade Via TFTP HTTP HTTPS

Firmware Server Path:

Config Server Path:

XML Config File Password:

HTTP/HTTPS User Name:

HTTP/HTTPS Password:

Firmware File Prefix: Firmware File Postfix:

Config File Prefix: Config File Postfix:

Allow DHCP Option 66 to override server:
 No Yes

Automatic Upgrade:
 No Yes, every minutes(30-5256000).
 Yes, daily at hour (0-23). Yes, weekly on day (0-6).

Always Check for New Firmware at Boot up
 Check New Firmware only when F/W pre/suffix changes
 Always Skip the Firmware Check

Figure 10: Firmware Upgrade Page



Upgrading via Local Directory:

1. Download the firmware file from Grandstream web site;
2. Unzip it and copy the file in to a folder in your PC;
3. From the HT802 web interface (Advanced Settings page) you can browse your hard drive and select the folder you previously saved the file (HT802fw.bin);
4. Click "Upload Firmware" and wait few minutes until the new program is loaded.

Note: Always check the status page to see that the program version has changed.

Upgrading via Local TFTP/HTTP Servers

For users that would like to use remote upgrading without a local TFTP/HTTP server, Grandstream offers a NAT-friendly HTTP server. This enables users to download the latest software upgrades for their devices via this server. Please refer to the webpage:

<http://www.grandstream.com/support/firmware>

Alternatively, users can download a free TFTP or HTTP server and conduct a local firmware upgrade. A free window version TFTP server is available for download from:

http://www.solarwinds.com/products/freetools/free_tftp_server.aspx

<http://tftpd32.jounin.net/>.

Instructions for local firmware upgrade via TFTP:

1. Unzip the firmware files and put all of them in the root directory of the TFTP server.
2. Connect the PC running the TFTP server and the phone to the same LAN segment.
3. Launch the TFTP server and go to the File menu->Configure->Security to change the TFTP server's default setting from "**Receive Only**" to "**Transmit Only**" for the firmware upgrade.
4. Start the TFTP server and configure the TFTP server in the phone's web configuration interface.
5. Configure the Firmware Server Path to the IP address of the PC.
6. Save and Apply the changes and reboot the HT802.

End users can also choose to download a free HTTP server from <http://httpd.apache.org/> or use Microsoft IIS web server.

Firmware and Configuration File Prefix and Postfix

Firmware Prefix and Postfix allows device to download the firmware name with the matching Prefix and Postfix. This makes it the possible to store all of the firmware with different version in one single directory. Similarly, Config File Prefix and Postfix allows device to download the configuration file with the matching Prefix and Postfix. Thus multiple configuration files for the same device can be stored in one directory.



In addition, when the field “Check New Firmware only when F/W pre/suffix changes” is set to “Yes”, the device will only issue firmware upgrade request if there are changes in the firmware Prefix or Postfix.

Managing Firmware and Configuration File Download

When “Automatic Upgrade” is set “**Yes, every**” the auto check will be done in the minute specified in this field. If set to “**daily at hour (0-23)**”, Service Provider can use P193 (Auto Check Interval) to have the devices do a daily check at the hour set in this field with either Firmware Server or Config Server. If set to “**weekly on day (0-6)**” the auto check will be done on the day specified in this field. This allows the device periodically check if there are any new changes need to be taken on a scheduled time. By defining different intervals in P193 for different devices, Server Provider can spread the Firmware or Configuration File download in minutes to reduce the Firmware or Provisioning Server load at any given time.

Configuration File Download

Grandstream SIP Devices can be configured via the Web Interface as well as via a Configuration File (binary or XML) through TFTP or HTTP/HTTPS. The **Config Server Path** is the TFTP or HTTP/HTTPS server path for the configuration file. It needs to be set to a valid URL, either in FQDN or IP address format. The **Config Server Path** can be the same or different from the **Firmware Server Path**.

A configuration parameter is associated with each particular field in the web configuration page. A parameter consists of a Capital letter P and 2 to 3 (Could be extended to 4 in the future) digit numeric numbers. i.e., P2 is associated with the "New Password" in the Web GUI->Maintenance->Web/SSH Access page->Admin Password. For a detailed parameter list, please refer to the corresponding firmware release configuration template.

When the HT802 boots up or reboots, it will send a request to download a file named "cfgxxxxxxxxxxx" followed by a configuration XML file named "cfgxxxxxxxxxxx.xml", where "xxxxxxxxxxx" is the MAC address of the phone, i.e., "cfg000b820102ab" and "cfg000b820102ab.xml". If the download of "cfgxxxxxxxxxxx.xml" file is not successful, the provision program will download a generic cfg.xml file. The configuration file name should be in lower case letters.

For more details on XML provisioning, please refer to:

http://www.grandstream.com/sites/default/files/Resources/gs_provisioning_guide.pdf



RESTORE FACTORY DEFAULT SETTINGS

Warning:

Restoring the Factory Default Settings will delete all configuration information on the phone. Please backup or print all the settings before you restore to the factory default settings. Grandstream is not responsible for restoring lost parameters and cannot connect your device to your VoIP service provider.

There are three (3) methods for resetting your unit:

Using the Reset Button

To reset default factory settings using the reset button please follow the steps above:

1. Unplug the Ethernet cable.
2. Locate the reset hole on the back panel of your HT802.
3. Insert a pin in this hole, and press for about 7 seconds.
4. Take out the pin. All unit settings are restored to factory settings.

Using the IVR Command

Reset default factory settings using the IVR prompt:

1. Dial “****” for voice prompt.
2. Enter “99” and wait for “reset” voice prompt.
3. Enter the encoded MAC address (Look below on how to encode MAC address).
4. Wait 15 seconds and device will automatically reboot and restore factory settings.

Encode the MAC Address

1. Locate the MAC address of the device. It is the 12-digit HEX number on the bottom of the unit.
2. Key in the MAC address. Use the following mapping:
 - 0-9: 0-9
 - A: 22 (press the “2” key twice, “A” will show on the LCD)
 - B: 222
 - C: 2222
 - D: 33 (press the “3” key twice, “D” will show on the LCD)
 - E: 333



- F: 3333

For example: if the MAC address is 000b8200e395, it should be keyed in as “0002228200333395”.

Reset from Web Interface (Reset Type)

1. Access your HT802 UI by entering its IP address in your favorite browser.
2. Enter your admin password (default: admin).
3. Press **Login** to access your settings.
4. Go to **Basic Settings > Reset Type**.
5. Press **Reset** button (after selecting the reset type).

- **Full Reset:** This will make a full reset.
- **ISP Data:** This will reset only the basic settings, like IP mode, PPPoE and Web port.
- **VOIP Data:** This will reset only the data related with a service provider like SIP server, sip user ID, provisioning and others.

Note:

- Factory Reset will be disabled if the “Lock keypad update” is set to “Yes”.
- If the HT802 was previously locked by your local service provider, pressing the RESET button will only restart the unit. The device will not return to factory default settings.



EXPERIENCING HT802

Please visit our website: <http://www.grandstream.com> to receive the most up- to-date updates on firmware releases, additional features, FAQs, documentation and news on new products.

We encourage you to browse our [product related documentation](#), [FAQs](#) and [User and Developer Forum](#) for answers to your general questions. If you have purchased our products through a Grandstream Certified Partner or Reseller, please contact them directly for immediate support.

Our technical support staff is trained and ready to answer all of your questions. Contact a technical support member or [submit a trouble ticket online](#) to receive in-depth support.

Thank you again for purchasing Grandstream analogue telephone adapter, it will be sure to bring convenience to both your business and personal life.

